



User Manual

DL-210 Label & Barcode Printer



Important Safety Instructions (English)

Read the following instructions thoroughly before starting up your printer.

- Never carry out maintenance or repair work yourself. Always contact a qualified service technician.
- Keep this Operator's Manual in a place which is easily accessible at all times.
- Place the printer on a solid and even base so that it cannot fall.
- Never place the printer in the vicinity of inflammable gas or explosive substances.
- Ensure the printer is connected to a socket with the correct mains voltage.
- Always disconnect the printer from the mains before opening the device to perform maintenance work or remedy errors.
- Do not expose the printer to high temperatures, direct sunlight or dust.
- Keep all liquids away from the printer.
- Protect the printer from shock, impact and vibration.
- Make sure that the printer and computer are switched off before connecting the data cable.
- The print head will become very hot during printing; avoid contact with the print head after printing has finished.
- Do not perform any operation or action in any way other than those provided in this manual. When in doubt, contact your dealer or your customer support.



The device and mains-socket must at all times be easily accessible.

Wichtige Sicherheitshinweise (German)

Lesen Sie bitte diese Sicherheitshinweise durch, bevor Sie den Drucker in Betrieb nehmen.

- Führen Sie Wartungsarbeiten und Reparaturen keinesfalls selbst aus, sondern verständigen Sie immer einen qualifizierten Servicetechniker.
- Bewahren Sie diese Dokumentation an einem jederzeit zugänglichen Ort auf.
- Den Drucker auf stabilem und ebenem Untergrund so aufstellen, dass er nicht zu Boden fallen kann.
- Stellen Sie den Drucker keinesfalls in der Nähe von leicht entzündlichen Gasen oder explosiven Stoffen auf.
- Den Drucker nur an eine Steckdose mit der richtigen Spannung anschließen.
- Wenn Sie den Drucker vom Netz trennen wollen, den Drucker ausschalten und immer den Netzstecker an der Steckdose ziehen.
- Den Drucker weder hohen Temperaturen noch direktem Sonnenlicht und Staub aussetzen.
- Keine Flüssigkeiten mit dem Drucker in Berührung bringen.
- Den Drucker keinen Erschütterungen, Stößen oder Vibrationen aussetzen.
- Sicherstellen, dass der Drucker und der Computer ausgeschaltet sind, bevor das Datenkabel angeschlossen wird.
- Der Druckkopf wird während des Druckens heiß. Vor dem Berühren deshalb einige Zeit abkühlen lassen.
- Weichen Sie bei der Bedienung des Druckers nicht von den Anweisungen in der Dokumentation ab. Bei Unklarheiten wenden Sie sich bitte an Ihren Händler oder Ihren Kundendienst.
- Maschinenlärminformationen – Verordnung – 3.GPSGV, der höchste Schalldruckpegel beträgt 70 dB(A) oder weniger gemäß EN ISO 7779.



Das Gerät und die Netzsteckdose müssen jeder Zeit leicht zugänglich sein.

Consignes importantes de sécurité (French)

Lire attentivement les instructions suivantes avant de mettre l'imprimante en service.

- Ne jamais effectuer soi-même les travaux d'entretien et de réparations. Contacter toujours un dépanneur qualifié.
- Placer l'imprimante sur un support stable de façon à ce qu'elle ne puisse pas tomber.
- Ne jamais placer l'imprimante à proximité de sources de gaz aisément inflammables ou de substances explosives.
- Ne connecter l'imprimante à une prise que lorsque la tension est correcte.
- Pour déconnecter l'imprimante de l'alimentation principale, mettre l'imprimante hors tension et toujours débrancher le connecteur secteur de la prise murale.
- Ne pas exposer l'imprimante à des températures élevées, à la lumière directe du soleil ou à la poussière.
- Ne pas mettre l'imprimante en contact avec des liquides.
- Ne pas exposer l'imprimante à des chocs, impacts ou vibrations.
- S'assurer que l'imprimante et l'ordinateur sont hors tension avant de connecter le câble de données.
- La tête d'impression est brûlante pendant l'impression. C'est pourquoi laissez-la refroidir quelques instants avant d'y toucher.
- N'exécutez aucune opération ni action d'une autre manière que celle indiquée dans ce manuel. En cas de doute, veuillez contacter votre distributeur ou service après-vente.



Le dispositif et la prise principale doivent toujours être accessibles facilement.

Indicazioni di sicurezza importanti (Italian)

Prima di mettere in funzione la stampante, leggere attentamente le seguenti indicazioni.

- Non eseguire mai da sé gli interventi di manutenzione e riparazione, ma rivolgersi sempre a un tecnico di assistenza qualificato.
- Conservare le presenti istruzioni per l'uso in un luogo sempre accessibile.
- Collocare la stampante su una superficie stabile, per evitare che cada a terra.
- Non collocare la stampante in prossimità di gas facilmente infiammabili o di sostanze esplosive.
- Collegare la stampante a una presa di corrente con tensione adeguata.
- Per scollegare la stampante dalla rete di alimentazione, spegnere la stampante e disinserire sempre il connettore di rete dalla presa.
- Non esporre la stampante ad elevate temperature né alla luce solare diretta e alla polvere.
- Evitare il contatto della stampante con liquidi.
- Non esporre la stampante a colpi, scosse o vibrazioni.
- Verificare che la stampante e il computer siano spenti prima di collegare il cavo di trasmissione dati.
- Durante la stampa, la testina si surriscalda notevolmente. Prima di toccarla, se necessario opportuno quindi lasciarla raffreddare qualche istante.
- Non eseguire alcuna operazione o azione se non nella maniera descritta nel presente manuale. In caso di dubbio, contattare il rivenditore o dalla società incaricata dell'assistenza.



Il dispositivo e la presa di corrente devono essere sempre facilmente accessibili.

Instrucciones de seguridad importantes (Spanish)

Lea las siguientes instrucciones con esmero antes de poner la impresora en servicio.

- Nunca lleve a cabo trabajos de mantenimiento o reparación Ud. mismo, sino consulte a un técnico de servicio calificado.
- Guarde las presentes instrucciones de servicio en un lugar de fácil acceso en cualquier momento.
- Ponga la impresora sobre un base estable de manera que no pueda caer al suelo.
- Nunca coloque la impresora en la vecindad de gases de fácil inflamabilidad o sustancias explosivas.
- Asegure conectar la impresora sólo a un enchufe con un voltaje correcto.
- Cuando quiera desconectar la impresora de la red, apague la impresora y siempre tire la clavija de alimentación del enchufe.
- No exponga la impresora a temperaturas altas, a la luz solar directa y al polvo.
- No ponga la impresora en contacto con fluidos.
- Nunca exponga la impresora a sacudidas, choques o vibraciones.
- Asegúrese de que la impresora y el ordenador estén apagados antes de conectar el cable de datos.
- La cabeza de impresión se pone muy caliente durante la impresión. Por lo tanto, deje enfriarlo algún tiempo antes de tocarla.
- No permita que se realice cualquier operación o acción de una forma diferente a lo que se señala en el manual. En caso de duda, póngase en contacto con su comerciante o con su servicio post-venta.



El dispositivo y la toma de corriente deben estar ubicados de forma que sea fácil acceder a ellos.

Правила по технике безопасности. (Russian)

Прочитайте, пожалуйста, инструкцию по технике безопасности перед включением в работу принтера.

- Не выполняйте технические работы и ремонт техники самостоятельно, но сообщайте о неисправностях квалифицированным сервисным техникам.
- Данная инструкция должна быть всегда доступна каждому пользователю.
- Установите принтер на ровном и стабильном месте так, чтобы он не смог упасть на пол.
- Ни в коем случае не ставьте принтер вблизи легко воспламеняющихся газов и взрывчатых веществ.
- Включайте принтер в розетку только с соответствующим напряжением.
- Если Вы хотите отключить принтер от напряжения, сначала выключите принтер сам и затем выньте штекер из розетки.
- Берегите принтер от нагревания, от попадания на него прямых солнечных лучей и пыли.
- Не допускайте попадания жидкости на принтер.
- Нельзя подвергать принтер тряске, ударам и вибрации.
- Убедитесь, что принтер и компьютер выключены, только после этого соедините принтер с компьютером.
- Печатающая головка нагревается во время работы принтера. Поэтому подождите какое-то время, прежде чем дотронуться до нее.
- Пользуйтесь принтером так, как это написано в документации. Если у Вас возникают неясности, обращайтесь с вопросами к Вашим продавцам или в сервисный центр.



Устройство и розетка должны быть всегда легко доступна.

Instruções Importantes sobre Segurança (Portuguese)

Leia as instruções de segurança antes de usar a impressora.

- Consulte sempre um técnico qualificado para executar uma reparação .
- Coloque a impressora sobre uma base sólida e nivelada, para que ela não sofra quedas.
- Jamais instale a impressora nas proximidades de lugares onde haja gás inflamável ou substâncias explosivas.
- Assegure-se de conectar a impressora à tomada elétrica com a voltagem apropriada.
- Quando desligar a impressora da rede, desligue sempre a impressora e retire o cabo da tomada.
- Não exponha a impressora a temperaturas altas ou luz solar direta.
- Não aproxime substâncias líquidas da impressora.
- Proteja a impressora de choques, impactos e vibrações.
- Desligue a impressora e o computador antes de conectar o cabo da rede.
- A cabeça da impressora pode ficar muito quente . Portanto, espere algum tempo antes de tocá-la.
- Não faça nenhuma operação ou ação além das recomendadas neste manual. Em caso de dúvida, contate seu revendedor ou companhia de serviço.



A impressora e a tomada devem ser facilmente em todos os momentos acessíveis.

Önemli Güvenlik Talimatları (Turkish)

Lütfen, yazıcıyı işleme geçirmeden önce bu güvenlik talimatlarını bütünüyle dikkatle okuyun.

- Bakım ve tamir çalışmalarını kesinlikle ve hiçbir surette kendi başınıza yapmayın; her zamankalifiyebir uzman servis-teknisyenine haber verin.
- Yazıcıyı, üzerinden yere düşmesimümkün olmayacak sabitve düz bir zemine yerleştirin.
- Yazıcıyı kesinlikle ve hiçbir surette kolayca yanabilecek gaz veya patlayıcı maddeler içeren nesnelere yakınına koymayın.
- Yazıcıakım kablosunu sadece doğru gerilime sahipbir prize takın.
- Yazıcıyı şebeke ağından ayırmak istediğinizde, yazıcıyı kapatın ve ağ-fişini her zaman prizden çıkartın.
- Yazıcıyı ne yüksek ısı ne de doğrudan güneş ışığına ve toza mâruz kalanmekânlarda bulundurun.
- Yazıcıhiçbir sıvı maddeyle temasta olmamalıdır.
- Yazıcı hiçbir sarsıntıya, darbeye veya titreşime mâruz kalmamalıdır.
- Veri kablosu bağlanmadan önce hem yazıcının hem de bilgisayarın kapalı olduklarından emin olmalısınız.
- Yazıcının başı basma esnasında yüksek ısıya ulaşır. Bu yüzden lütfen dokunmadan önce kısa süre soğumasını bekleyin.
- Yazıcının işletimi ve kullanımında bu dokümantasyondaki talimatların hiç dışına çıkmayın. Sorunlu görünen hususlarda lütfen imâlatçınıza veya müşteri hizmetleri servisimize başvurun.



Cihaz ve elektrik prizinin her zaman kolayca erişilebilir olması gerekir.

TRADEMARK ACKNOWLEDGEMENTS

“IBM” is a trademark of International Business Machines Corporation.

“EPSON” is a trademark of Epson America Incorporated.

“DEC” is a trademark of Digital Equipment Corporation.

“Centronics” is a trademark of Centronics Data Computer Corporation.

“DOS” is a trademark of Microsoft Corporation.

“SAP” is a trademark of SAP AG.

“Windows”, “Windows 7”, “Windows 8”, “Windows 10”, “Windows 95”, “Windows 98”, “Windows NT”, “Windows 2000”, “Windows 2003/2008/2013 Server”, “Windows XP” and “Windows Vista” are trademarks of Microsoft Corporation.

All other product names and company names appearing in this manual are the registered trademarks or trademarks of the individual companies.

APPROVALS



This device fulfils the European standards requirements by complying with the Directive relating to electromagnetic compatibility and relating to low-voltage electrical equipment. Furthermore, it fulfils the requirements for RoHS and RED if applicable.

Conformity with the above-mentioned Directives is indicated by the CE symbol attached to the device.

Note: Conformity may be affected by:

- using interface cables not complying with the specifications
- non-observance of important instructions in the operator’s manual
- installing components not approved for this device by the manufacturer
- unauthorized manipulation



Dieses Gerät erfüllt die Anforderungen der Europäischen Normen durch Einhaltung der Richtlinien bezüglich der Elektromagnetischen Verträglichkeit sowie bezüglich Elektrischer Betriebsmittel mit Niederspannung. Des Weiteren werden die Anforderungen bezüglich RoHS und falls anwendbar RED erfüllt.

Die Konformität zu den oben angeführten Richtlinien ist durch das am Gerät angebrachte CE-Zeichen gekennzeichnet.

Hinweis: Die Konformität kann beeinflusst werden durch:

- Benutzung von nicht spezifizierten Schnittstellen
- Nichtbeachtung wichtiger Hinweise der Bedienungsanleitung
- Ersetzen von Bauteilen, die nicht vom Hersteller für dieses Gerät freigegeben wurden
- Eingriffe durch Unbefugte



This device complies with the requirements of the United Kingdom (UK) legislation of Electrical Safety Regulations, Electromagnetic Compatibility Regulations, if applicable the Radio Regulations and the Restriction of the Hazardous Substances in Electrical and Electronic Equipment Regulations.

About This Manual

This manual provides information to operators of the DL-210 to describe basic operations to enable safe and correct use of the printer.

Symbols Description

The symbols in this manual are identified by their level of importance, as defined below. Read the following carefully before handling the product.



CAUTION: Provides information that must be observed to prevent damage to the equipment or data loss.



NOTE: Advises you of information that is essential to complete a task.

Related Software and Documents

Related Software and Documents

Software/document name	Description
DL-210 User Manual	This manual.
DL-210 Maintenance Manual	This manual provides developer/ engineers with additional technical information.

Contents

CHAPTER 1 INTRODUCTION.....	1
1.1 Features.....	1
1.2 Printer specifications.....	2
1.3 Print Media Types.....	4
1.4 External Dimension and Weight.....	6
1.5 Unpacking.....	7
1.6 Product Configuration.....	9
1.7 Printer Components.....	10
1.8 Control Panel.....	13
1.8.1 LEDs Behavior.....	13
1.8.2 Feed Button Operation.....	13
CHAPTER 2 SETUP.....	14
2.1 Flow of Setup.....	14
2.2 Placing the Printer.....	14
2.3 Attaching Power.....	15
2.4 Calibrate Sensor.....	16
2.4.1 Calibrate Gap Sensor.....	16
2.4.2 Calibrate Reflective Sensor.....	16
2.5 Loading Roll Media.....	18
2.6 Loading Transfer Ribbon.....	20
2.7 Connecting to Computer.....	23
2.7.1 Connecting USB Interface.....	24
2.7.2 Connecting Serial Interface.....	24
2.7.3 Connecting Parallel Interface.....	25
2.7.4 Connecting Ethernet Interface.....	25
2.7.5 Connecting Wlan Interface.....	26
CHAPTER 3 NETWORK SETUP AND CONFIGURATION.....	1
3.1 Installing Driver.....	1
3.2 Installing Setup Tool.....	4
3.3 Setup Tool Application.....	8
3.3.1 Model and Interface Setting.....	8
3.3.2 Configuring Printer.....	9
3.4 LAN Interface Setup.....	11
3.5 WLAN Interface Setup.....	13
3.6 Install Bluetooth Adapter Driver.....	15
3.7 Bluetooth Setup.....	20
3.8 Update Firmware.....	22
3.9 Cutter and Peeler Setup (Option)	24
CHAPTER 4 SETTING/CHECKING MODES.....	26
4.1 Print a Parameter Setting Page (Self-test Page).....	26
4.2 Hexadecimal Dumping Mode.....	28
4.3 Auto Calibrate Label.....	29
CHAPTER 5 TROUBLESHOOTING AND MAINTENANCE.....	30

5.1 Common Issues.....	30
5.2 Resetting the Factory Default Values.....	31
5.3 Removing Jammed Label.....	31
5.4 Cleaning Thermal Print Head.....	32
5.5 Maintenance.....	32
CHAPTER 6 COMMUNICATION INTERFACES SPECIFICATIONS.....	33
6.1 USB Interface.....	33
6.2 Wi-Fi Interface.....	33
6.3 Bluetooth Interface.....	33
6.4 Ethernet Interface.....	33
6.5 Serial Interface.....	34
6.6 Parallel Interface.....	35
6.7 Power Supply.....	36
CHAPTER 7 CHARACTER CODE PAGES.....	37
7.1 Common to All Pages (International Character Set: Usa).....	37
7.2 International Character Sets.....	38
7.3 [User-Defined Page].....	39
7.4 [PC437: USA, Standard Europe].....	40
7.5 [PC850: Multilingual].....	41
7.6 [PC852: Latin2].....	42
7.7 [PC858: Euro].....	43
7.8 [PC860: Portuguese].....	44
7.9 [PC863: Canadian-French].....	45
7.10 [PC865: Nordic].....	46
7.11 [PC866: Cyrillic #2].....	47
7.12 [PC720: Arabic].....	48
CHAPTER 8 COMMAND SETS.....	49
8.1 ZPL Command Sets.....	49
8.2 EPL Command Sets.....	55
8.3 TSPL Command Sets.....	56
Appendix I: AUTOCUTTER (OPTION)	57
Removing the Tear Bar.....	57
Installing the Auto Cutter.....	59
Appendix II: PEELER (OPTION)	61
Appendix III: FCC STATEMENT.....	62

CHAPTER 1 INTRODUCTION

The Dascom DL-210 model is the best value in a desktop thermal printer. The DL-210 printer provides thermal transfer and direct thermal printing at speeds up to 6 ips (inches per second) at a 203 dpi (dots per inch) print density.

1.1 Features

- Easy to switch printer language between ZPL, EPL and TSC programming and label formats.
- Easy operation. With an open structure users can easily change paper roll and ribbon.
- Large media compartment. Ribbon as long as 300m and paper roll of Max. OD \varnothing 127mm can be used. Therefore users can change the ribbon and paper roll less often so as to work more efficiently.
- Wide range of connectivity. The USB interface is standard interface. Serial/parallel/Ethernet/Wi-Fi/ Bluetooth are optional interfaces. Various interface choices suit all needs.

The DL-210 printers offer these basic printer options:

- Auto cutter.
- Peeler.

This user guide provides all the information you need to operate your printer on a daily basis.

1.2 Printer specifications

Print Parameter	Print method	Direct thermal/Thermal transfer printing
	Print width	108mm
	Print speed	6IPS
	Print head	Dot pitch: 0.125mm
	Resolution	203DPIx203DPI
Fonts	Chinese	GB18030 24x24 (Simplified/Traditional Chinese)
	Alphanumeric	Resident single byte (ZPL): Font A, Font B, Font D, Font E, Font F, Font G, Font H, Font V0, Font GS, Font P, Font Q, Font R, Font S, Font T, Font U, Font V
	User-defined	User-defined fonts can be downloaded into FLASH, SDRAM.
	Code Pages	EPL: PC437;PC850;PC852;PC860;PC863;PC865;PC865;PC857;PC861;PC862;PC855;PC866; PC737;PC851;PC869;Windows 1252;Windows 1250;Windows 1251; Windows 1253;Windows 1254;Windows 1255 ZPL: PC850, windows 1250, windows 1252, windows 1251, windows 1253, windows 1254, windows 1256
	Scalable/Rotation	Zoom in 1~8 times in vertical or horizontal, rotate by 0°, 90°, 180°, 270°.
Graphics		Graphics (Monochrome PCX, BMP) can be downloaded into SDRAM.
Barcodes	1D	ZPL: Code11;Interleaved 2 of 5;Code 39;Code 49;Planet Code; EAN-8;EAN-13;UPC-E;UPC-A;Code93;Code 128; Industrial 2 of 5;Standard 2 of 5;Codabar;MSI;Plessey EPL: EAN-8;EAN-13;UPC-E;UPC-A;Code 39;Code 93;Code 128; Interleaved 2 of 5
	2D	ZPL: PDF417;CODABLOCK;Maxicode;Aztec;QR Code; Data Matrix; EPL: PDF417;Maxicode;QR Code; Data Matrix;
Ribbon	ID	φ25.4mm
	OD	φ68mm
	Length	300m
	Width	33~110mm
Media Handling	Media Spec.	Thickness 0.06~0.18mm
		Width 25~118mm
		Length 8.9~400mm
		Max. OD φ127mm
	Min. ID φ25.4/38.1mm	
Media cut	Tear bar, auto-cutter, peeler	
Media type	Roll paper, fold paper (continuous, non-continuous, continuous tag, wrist-band, normal media and all sorts of receipts)	
Control Panel	Key	One key: Feed
	LED indicator	Three LEDs: Power, Error, Status (Paper out/Ribbon out)
Detect Function	Standard sensors	Black mark sensor, Media sensor, Ribbon sensor, Machinery sensor
	Optional kit sensor	Label taken sensor
Emulation	Zebra, EPSON	ZPL, EPL, TSPL

Power Supply		External power adapter
	Input	AC 100V-240V, 50-60Hz
	Output	24V DC, 3A
Memory	SDRAM	8MB
	FLASH	8MB
Interface	Standard	USB (2.0 Full-Speed)
	Optional	Serial (RS-232, DB25)
		Parallel Centronics (IEEE-1284)
		Ethernet: 10M/100M
		Wi-Fi (802.11b/g)
Bluetooth: BT 3.0/4.0+EDR, SPP		
Software		Driver (Windows 32bit/64bit), Bartender, SDK system, setup tool
Physical Spec.	Dimensions	230(W)×290(D)×176(H)mm
	Casing Color	Black
	Weight	Approx 3kg
	Operating condition	5 ~ 40°C / 20 ~ 95%RH (non-condensing)
	Storage condition	-20 ~ 60°C / ≤95%RH (non-condensing)
Safety Standard	Safety	UL, CE, FCC, CCC, EMC
	EMC	Class B
	Certificate	CCC, CE, FCC, UL, Energy star
Option	Cutter	Media width: 25mm~118mm Media thickness: 0.06mm~0.18mm
	Peeler	Media width: 25.4mm-100mm Media thickness: 0.06mm~0.18mm

1.3 Print Media Types



Important • Dascom strongly recommends the use of Dascom-brand supplies for continuous high-quality printing.

Your printer can use various types of media:

- Standard media—Most standard (non-continuous) media uses an adhesive backing that sticks individual labels or a continuous length of labels to a liner.
- Continuous roll media—Most continuous roll media is direct thermal media (similar to FAX paper) and is used for receipt or ticket style printing.
- Tag stock—Tags are usually made from a heavy paper (up to 0.0075in./0.19mm thick). Tag stock does not have adhesive or a liner, and it is typically perforated between tags.

For more information on basic media types, see the following table.

The printer typically uses roll media, but you can use fan-fold or other continuous media too. Use the correct media for the type of printing you require. You must use direct thermal media. When printing without a ribbon, you must use direct thermal media. When using ribbon, you must use thermal transfer media.

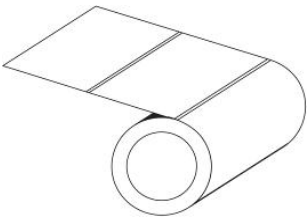
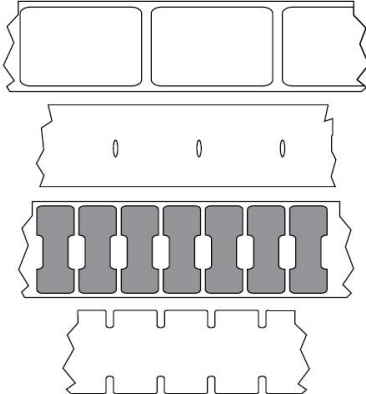
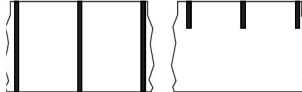
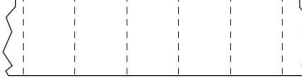
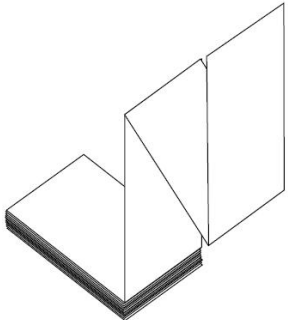
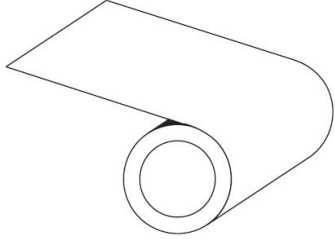
Media Type	How it looks	Description
<p>Non-Continuous Roll Media</p>		<p>Roll media is wound on a core that can be 1 to 1.5 in. (25.4 to 38.1 mm) in diameter. Labels have adhesive backing that sticks them to a liner, and gaps, holes, notches, or black marks separate them. Tags are separated by perforations. Individual labels are separated by one or more of the following methods:</p> <ul style="list-style-type: none"> • Web media separates labels by gaps, holes, or notches.  <ul style="list-style-type: none"> • Black mark media uses pre-printed black marks on the back side of the media to indicate label separations.  <ul style="list-style-type: none"> • Perforated media has perforations that allow the labels or tags to be separated from each other easily. The media may also have black marks or other separations between labels or tags. 
<p>Non-Continuous Fanfold Media</p>		<p>Fan-Fold media is folded in a zigzag pattern. Fanfold media can have the same label separations as non-continuous roll media. The separations would fall on or near the folds.</p>
<p>Continuous Roll Media</p>		<p>Roll media is wound on a core that can be 1 to 1.5 in. (25.4 to 38.1 mm) in diameter. Continuous roll media does not have gaps, holes, notches, or black marks to indicate label separations. This allows the image to be printed anywhere on the label. A cutter can be used to cut apart individual labels. With continuous media, use the transmissive (gap) sensor so the printer can detect when the media runs out.</p>

1.4 External Dimension and Weight

- Width: Approximately 230 mm
- Depth: Approximately 290 mm
- Height: Approximately 179.5 mm
- Mass: Approx. 3 kg (excluding power adapter)



Front View



Back view



Side view

1.5 Unpacking

When you receive the printer, please check for possible shipping damage:

1. Inspect the outside of both the box and the printer for possible damage.
2. Open the top cover of the printer to see if the media compartments are in order.

If you discover shipping damage upon inspection:

- Immediately notify the shipping company and file a damage report.
- Keep all packaging material for shipping company inspection.
- Notify your authorized Tally Dascom reseller.

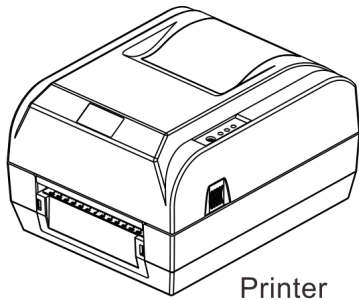

Printer

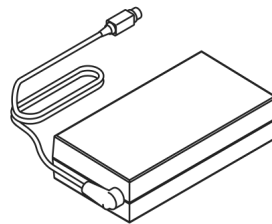

Power adapter

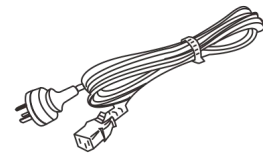

Power cord

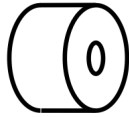

Media



Ribbon



Ribbon rewind paper core

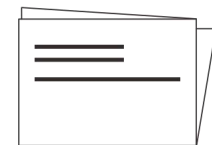

Installation guide



The package contents vary with different customized order requirements.

Package Contents:

Standard	Printer	1 unit	
	Ribbon rewind paper core	1 piece	
	Ribbon sample	1 piece	Wax
	Ribbon spindle	2 pieces	
	Media sample	1 piece	Thermal transfer
	Media fixer	2 pieces	
	Media spindle	1 piece	
	Power adapter	1 piece	
	Power cord	1 piece	EU/UK/US
	Installation guide	1 piece	
Optional	Peeler	1 set	
	Cutter	1 set	

1.6 Product Configuration

Interface Types



- USB interface (USB2.0, Full speed)
- Serial interface: Serial port (RS-232, DB25)
- Parallel interface: Bidirectional parallel port (IEEE1284)
- LAN interface: Ethernet (10Base-T, 100Base-TX)
- Wireless LAN interface: Wi-Fi (802.11b/g)
- Bluetooth interface (BT 3.0/4.0+EDR, SPP)

Model	Interfaces						Power Cord EN/UK/EU	Paper Cut		Sensor
	USB	PAR	SER	ETH	Wi-Fi	Bluetooth		Cutter	Tear Bar	Black Mark
DL-210	√	O	O	O	O	O	√	O	√	√

Remarks: “√” indicates standard configuration, “O” indicates optional configuration.

PAR=Parallel interface; SER= Serial interface; ETH=Ethernet interface.

1.7 Printer Components

Printer components and their functions are shown as below:



Component Name		Function
Media window		Monitor the media status via this window
Top cover		Open this cover for loading ribbon and media
Control Panel	Power LED	Indicate the power status
	Status LED	Indicate the status of media, ribbon and label-taken
	Error LED	Indicate print head temperature and if the print head mechanism is open or not
	Feed Button	Press this key for feeding media
Power socket		Connect power cord to the printer
Power switch		For switching on/off printer
USB interface		Connect USB interface cable from host
Optional interface (Serial/ Parallel/ Ethernet/ Wi-Fi/ Bluetooth)		Connect optional interface cable from host (interface type is on request)



Wi-Fi and Bluetooth are optional interface; they cannot be used at the same time.

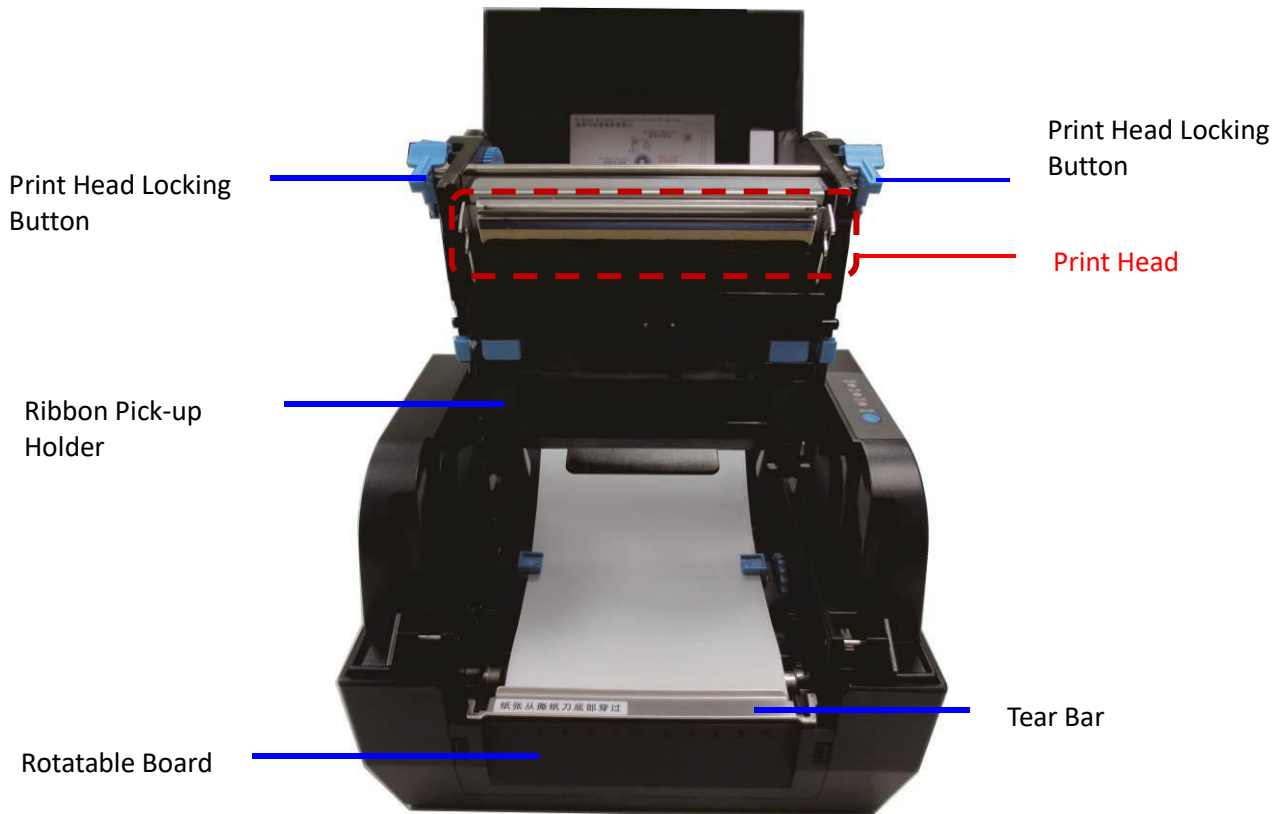
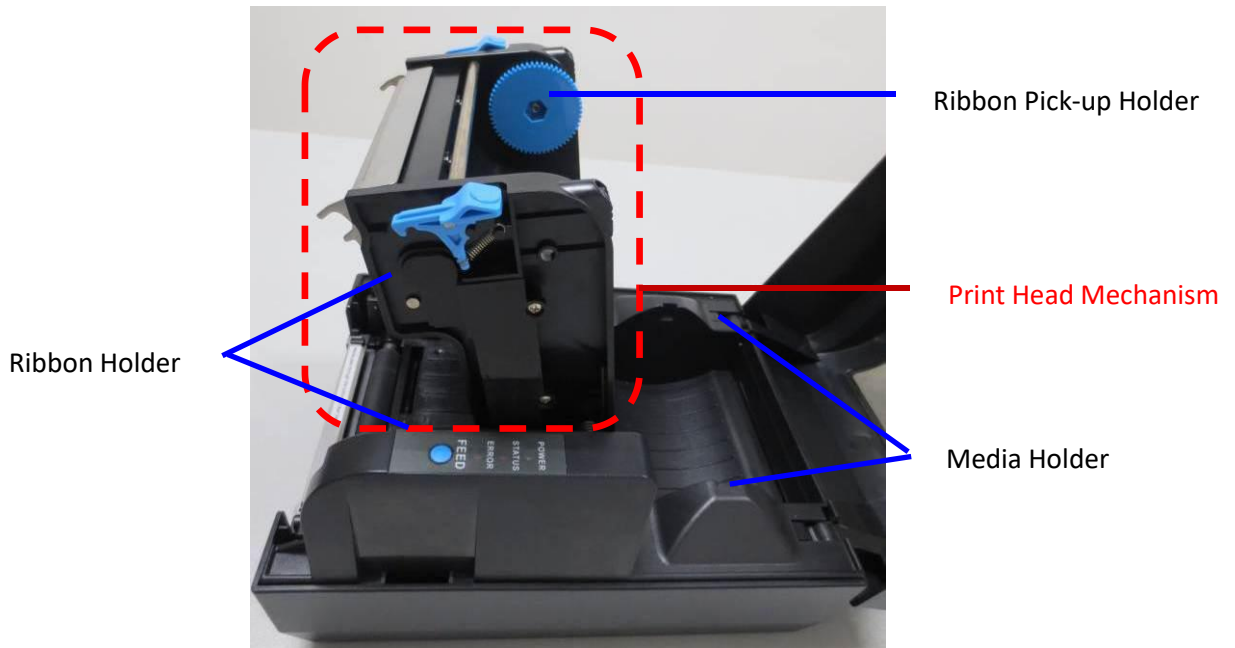

Component Name		Function
Print Head Mechanism	Ribbon Holder	For placing ribbon, lower seat for new ribbon, top seat for used ribbon.
	Print Head	Heat the ribbon and transfer imaging components to the media
Ribbon Pick-up Holder		Turn the adjuster for stretching ribbon
Media Holder		For placing media
Print Head Locking Button		For closing or opening the print head mechanism
Tear Bar		For tearing the media
Rotatable Board		Disassemble the rotatable board for installing optional kit: peeler or cutter

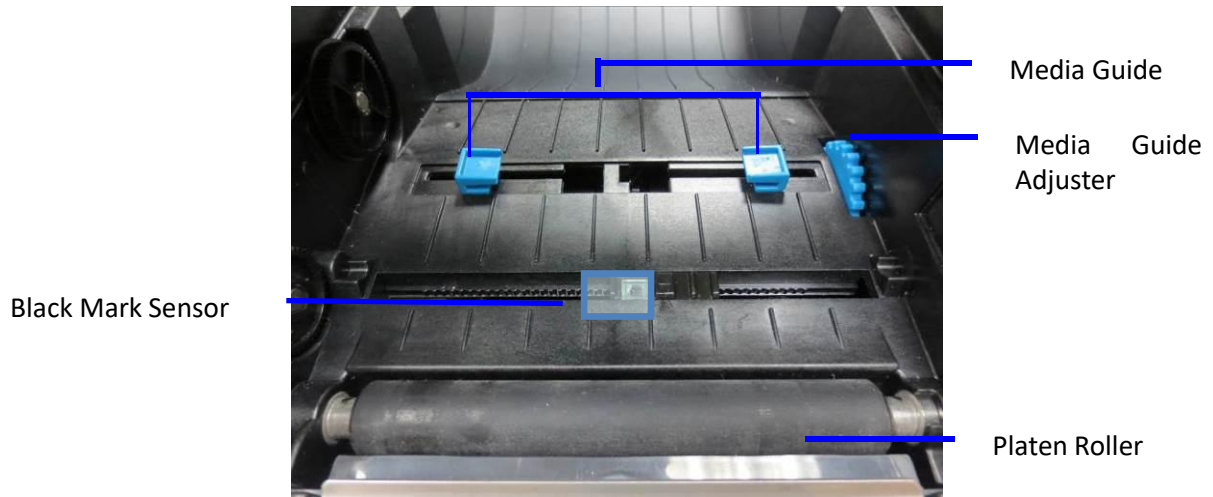

Component Name	Function
Media Guide	Align the media in the center of media path
Media Guide Adjuster	Adjust the space between the two media guides
Black Mark Sensor	For detecting black mark. The sensor position can be adjusted according to the black mark position.
Platen Roller	For feeding paper

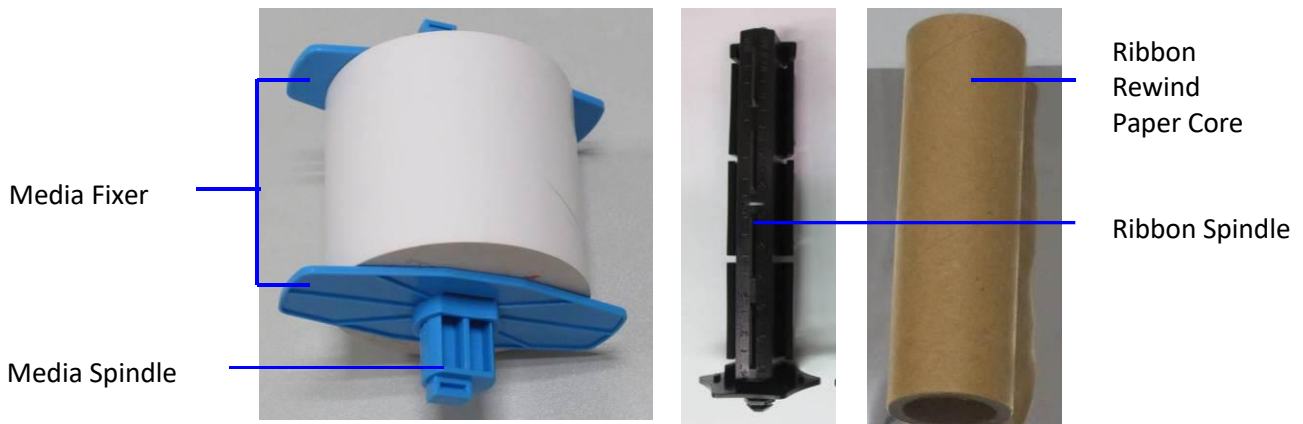

Component Name	Function
Media Spindle	Insert it into media core for supporting media
Media Fixer	For fixing media (as the above figure shown)
Ribbon Spindle	Install it in ribbon holder for supporting ribbon or ribbon rewind pipe
Ribbon Rewind Paper Core	Stick the used end of ribbon to the pipe, rewind ribbon while the pipe is turning

1.8 Control Panel

1.8.1 LEDs Behavior

	Power	Status	Error	Buzzer	Printer behavior
	On	Off	Off	1 beep	Standby.
	X	X	On	X	Print head mechanism is opened.
	X	On	Off	1 beep	Paper end.
	X	Slow blink	Off	1 beep	Ribbon end.
	X	X	Fast blink for 3 times	3 beep	Sign is not detected.
	X	X	Slow blink for 1 time, fast blink for 3 times	1 long beep, 3 short beep	Cutter error.
	Off	On	Off	2 beep	Enter FW upgrade mode.
	X	Fast blink	Off	X	Label remains in peeler.
	Off	X	X	X	Print pause (data is not completely printed)
	X	X	Fast blink	X	Print head is over-heated.

“X” represents the current status can be regardless, the printer behavior can be superimposed on each other, such as when ribbon error occurs, "ribbon end" and "data is not completely printed" may arise.

1.8.2 Feed Button Operation

- Below specified functions can be implemented when the printer is switched on.
 1. Holding the Feed button when switch on the printer, Self Test will be conducted with 1 beep indication.
 2. Holding the Feed button when switch on the printer, Auto Label Calibration will be implemented with 2 beeps indication.
 3. Holding the Feed button when switch on the printer, Hexadecimal Mode will be entered with 3 beeps indication.
 4. Holding the Feed button when switch on the printer, Factory Default Values will be reset with 4 beeps indication.
 5. Lift up the top cover and turn up the print head mechanism. Holding the Feed button when switch on the printer for 1s, Upgrade Mode will be entered with 2 beeps indication.
- Below paper feed behavior can be implemented when the printer is switched on.
 1. If Continuous Paper is set, the printer will feed the paper for 1 line (30 steps) under standby mode when pressing Feed button.
 2. If Continuous Paper is set, the printer will feed the paper continuously under standby mode when holding Feed button.
 3. If Label Paper is set, the printer will feed 1 pcs of label under standby mode when pressing Feed button.
 4. If Label Paper is set, the printer will not feed the paper under standby mode when holding Feed button.

CHAPTER 2 SETUP

2.1 Flow of Setup

This chapter consists of the following sections along with the setup flow of the product and peripherals.

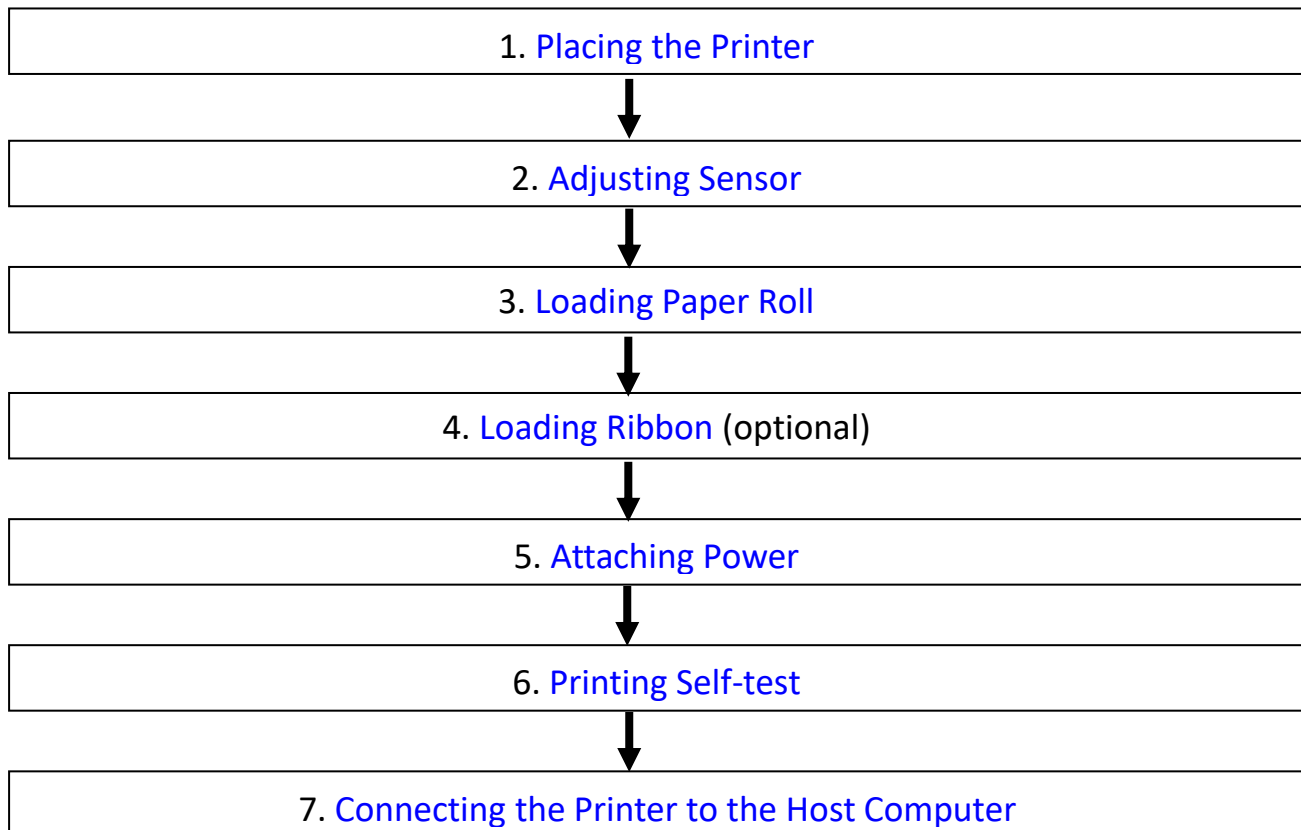

2.2 Placing the Printer

The printer must be installed horizontally. Place the printer on a solid, flat, stable surface; ensure the printer is placed in a stable position and there is easy access for users to the control panel and roll paper holder. Also ensure there is enough space for sufficient ventilation and for the printout.

When selecting the placement position, be aware of the following advice:

- Never place the printer near to any flammable gas or explosive substances.
- Do not expose the printer to direct sunlight. If you cannot avoid placing the printer near a window, protect it from the sunlight with a curtain.
- When connecting a computer to the printer, make sure the maximum recommended cable length is not exceeded.
- Ensure sufficient distance between the printer and any heating devices or radiators.
- Avoid exposing the printer to extreme temperature or air humidity fluctuations. Avoid exposure to dusty environments.
- It is recommended the printer is installed in a position which reduces noise exposure to the work place during printing.

2.3 Attaching Power

Checking the voltage of the power adapter



Before you connect the power adapter to the power socket check if the voltage is correct. If you connect the power adapter to power with incorrect voltage this may result in electrical damage to adapter and printer.

1. Make sure the printer and the computer are powered off.
2. Connect the power cord to the power adapter.
3. Connect the power adapter to the power supply interface at the rear of the printer.
4. Ensure the power cord is securely connected. Connect the power cord plug to a mains socket on the wall.

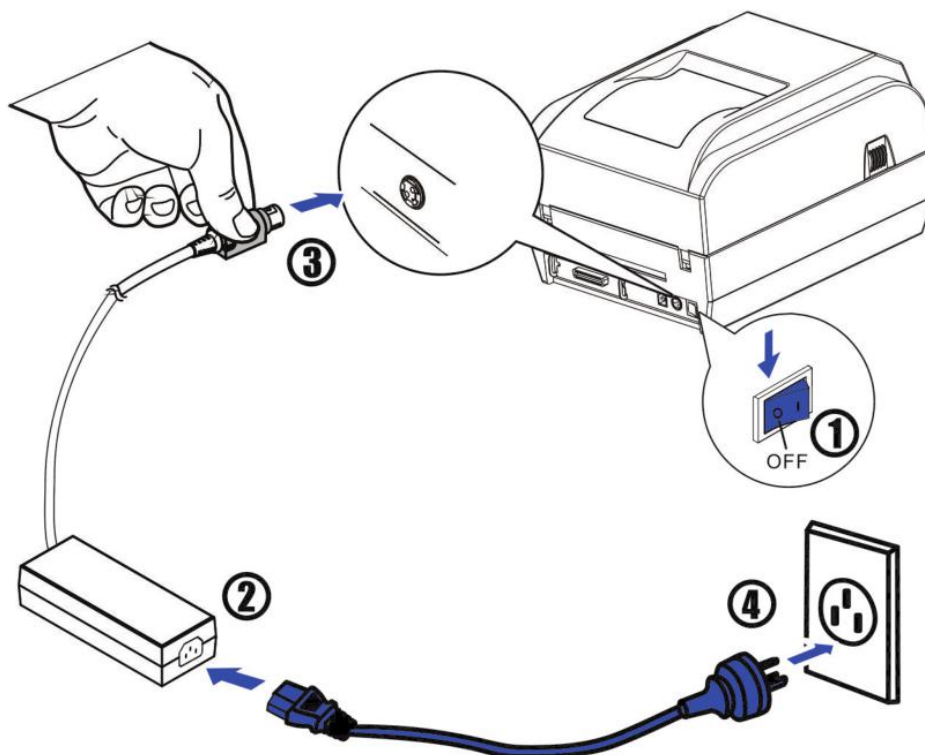

- 1) Please only use the power adapter recommended by supplier or equivalent products;
- 2) When disconnecting the AC adapter plug, handheld plug connector housing, avoid pulling on the cable;
- 3) Avoid placing power adapter nearby a heating device, otherwise the cable may melt, causing fire and shock;
- 4) If you do not use the printer in a long time, disconnect the power supply of printer power adapter.



2.4 Calibrate Sensor

Gap sensor and reflective sensor should be calibrated separately.

First, please open the setup tool, enter "Printer Setup", choose paper sensor: gap sensor by default. You could switch to reflective sensor according to your need.

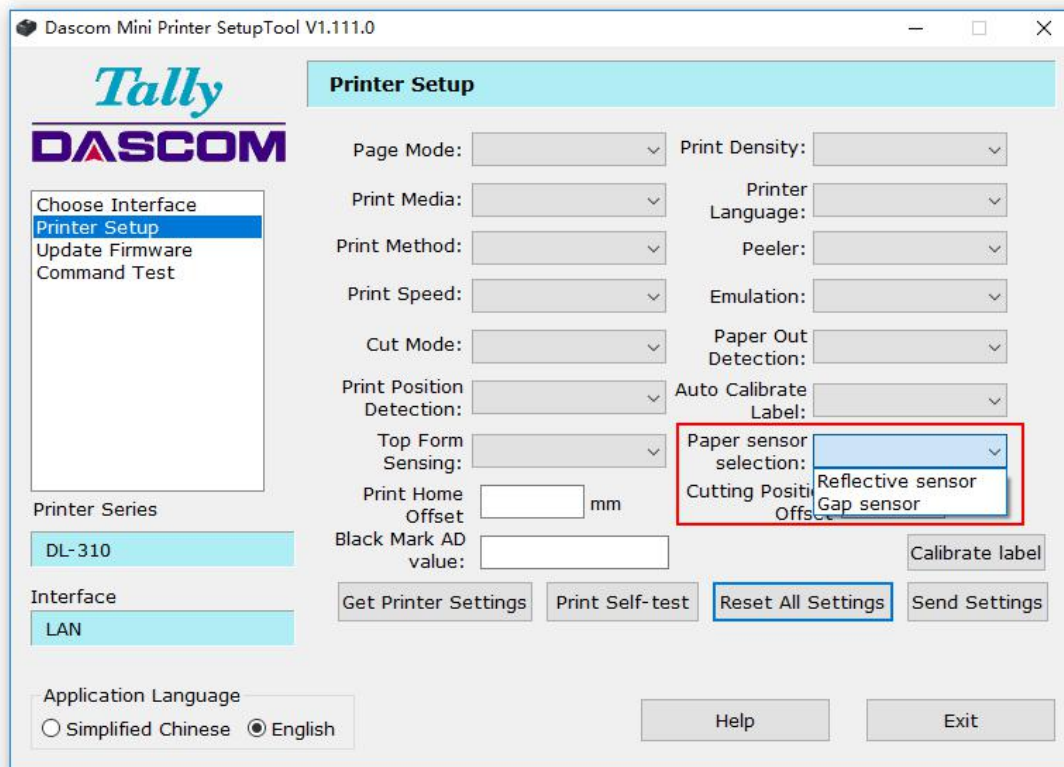

2.4.1 Calibrate Gap Sensor

- (1) Make sure gap sensor is selected through the setup tool.
- (2) Lift the top cover to expose the media holder and the print head mechanism.
- (3) Move around the sensor support so as to align its triangle with another triangle on the center housing. As it is shown below:

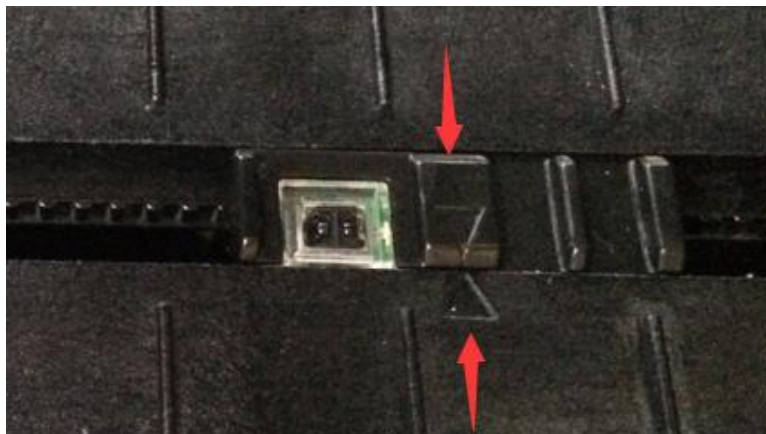

2.4.2 Calibrate Reflective Sensor

- (1) Select Reflective Sensor in the setup tool.
- (2) Lift the top cover to expose the media holder and the print head mechanism.
- (3) Align the black mark sign with the black mark sensor.

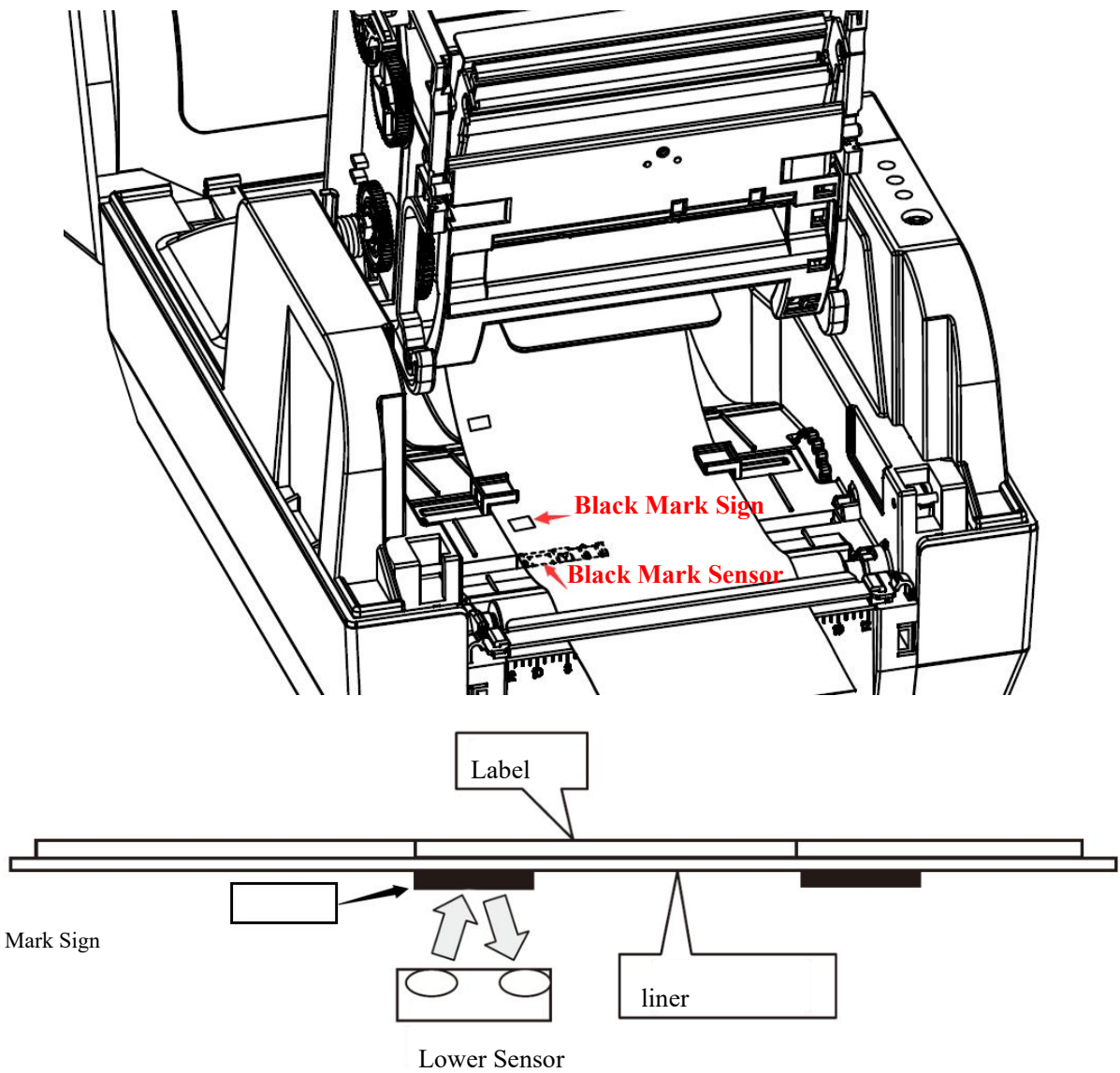

(4) Put the media between the media compartment and the tear bar. And then close the mechanism and the top cover.

2.5 Loading Roll Media



- Must use thermal media in case of no ribbon in the printer. When using ribbon, you have to use thermal transfer media.
- Tips for avoiding media jam: Make sure the media is aligned in the center of the printer and the media fixers are firmly pressed against both sides of the roll.

Before printing, it is necessary to check whether the media you use is appropriate or not. You can scratch the media surface, if the scratch turns black, it is direct thermal media. In this case, you do not need to load ribbon. Otherwise, it is thermal transfer media, you have to use a ribbon.



(1) Lift the top cover to expose the media holder and the print head mechanism.

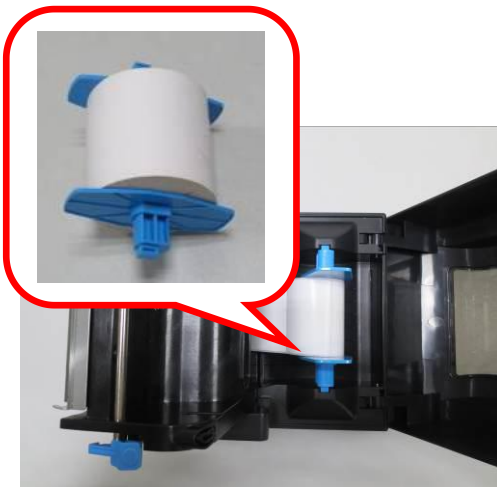

(2) Load the media roll onto the spindle from left to right.

(3) Put the fixers on and move from right to left until they lean against the media.

(4) Click the media spindle back into the media holder.



Print surface must be upward.

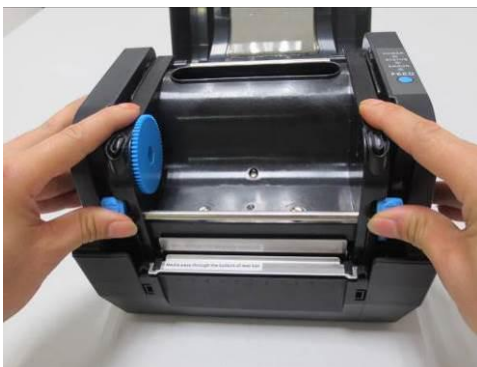

(5) Unlatch the print head mechanism by pushing the two blue locking buttons on the sides toward the rear.

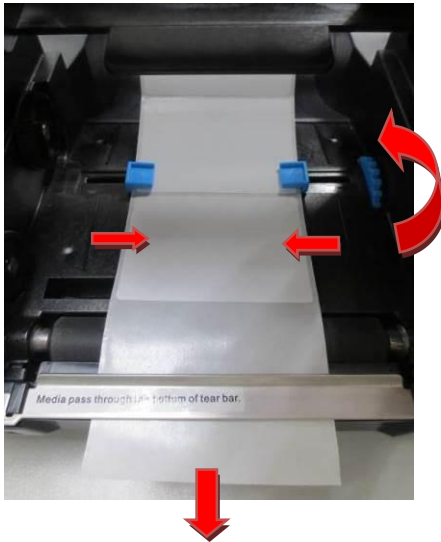

- (6) Lead the media under the print head mechanism through the media guides.
- (7) Control the blue media guide adjuster so as to align the media in the central path.
- (8) Lead the media over the platen roller and through the tear bar.



- (9) Put the print head mechanism down and press down firmly until you hear a snap.
- (10) Close the top cover and turn on the printer or press the "FEED" button if the printer is already on.

(11) In order to make sure the data is printed within the label area, it is necessary to execute Label Calibration: Hold down Feed Button and switch on printer simultaneously, release Feed Button after the buzzer beeps twice. Then the label will be positioned automatically.

Label calibration should be executed in the following situations:



- Use printer for printing label for the first time.
- After replacing different size of labels.
- If the printer skips labels
- If the printer feeds blank labels.
- After refilling with new roll of labels.

2.6 Loading Transfer Ribbon

Transfer ribbons come in several varieties and in some cases colors to match your application needs. The media and ribbon types should be matched to provide you with optimal print results. Always use ribbon that is wider than the media to protect the printhead from wear.



For direct thermal printing, do not load ribbon in the printer.



Do not use ribbon while using direct thermal media. Otherwise, barcode and graph will be distorted.



(1) Lift the top cover to expose the media holder and the print head mechanism.



(2) Unlatch the print head mechanism by pushing the two blue locking buttons on the sides toward the rear.

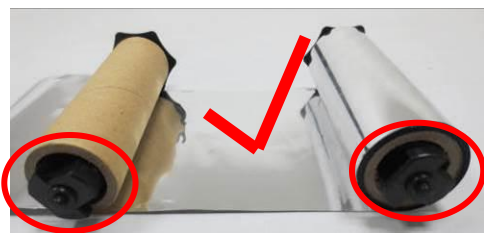

(3) Unwrap the ribbon roll pack and separate the ribbon roll and the bare paper core.

(4) Insert the spindles into the core and the ribbon respectively.

(5) Attach the edge of the ribbon on the bare paper core and wind it a little onto the core.

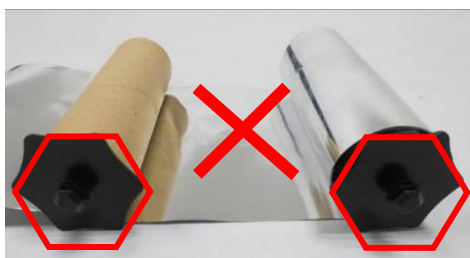

Pay attention of the direction of hexagon.



(6) Open the sensor support.

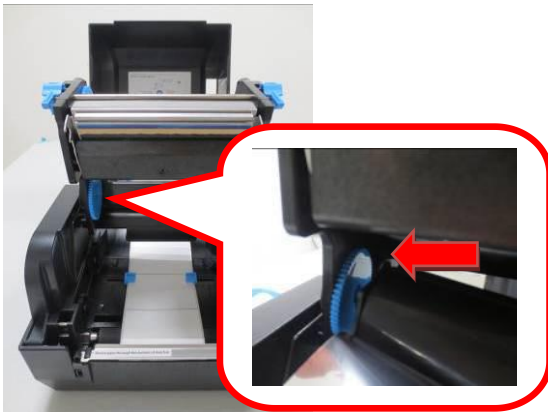

(7) Insert the ribbon roll into the ribbon holder (lower seat of the print head mechanism): Insert the hexagon end onto the ribbon adjuster (blue gear), then insert the other end into the slot of the ribbon holder.



(8) Turn back the print head mechanism and then insert the ribbon rewind paper core into the pick-up holder (top seat): Wind the ribbon through print head, and insert the spindle hexagon end onto the ribbon adjuster (blue gear), then insert the other end into the slot of the pick-up holder.

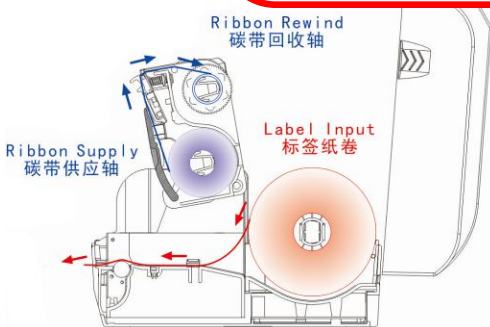

Keep the brighter surface of ribbon inside while winding the print head.



(9) Turn the wheel of the print head mechanism to ensure the ribbon is tightly wound.

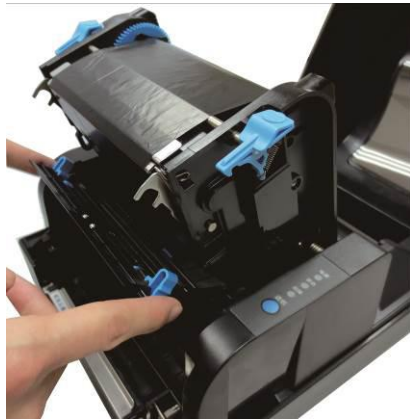

(10) Close the sensor support.



(11) Press down the print head mechanism on both sides firmly until you hear a snap.

2.7 Connecting to Computer



NOTE!

Be sure to install the driver before connecting the printer to the host computer.

Before installing, disconnect the Power Unit from the printer (as well as turning the power switch off). Even when the power switch is off, voltage is still present at some points on the circuit board. Changing components while the power unit is connected can cause damage to the interface board and the printer.

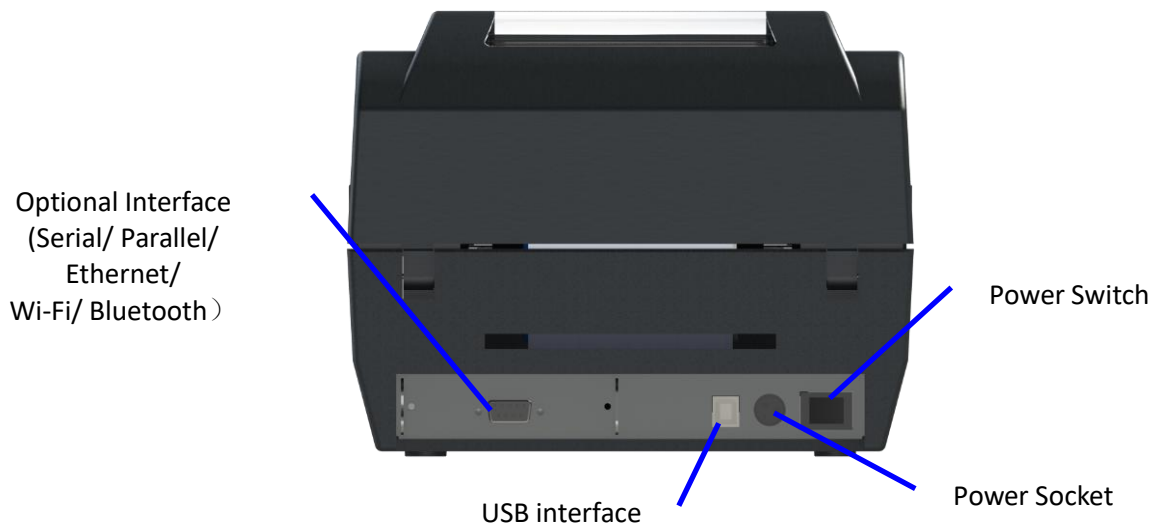

Component Name	Function
Power socket	Connect power cord to the printer
Power switch	For switching on/off printer
USB interface	Connect USB interface cable from host
Optional interface (Serial/ Parallel/ Ethernet/ Wi-Fi)	Connect optional interface cable from host (interface type is on request)

Connection cable must comply with the following requirements:

Connection Type	Specifications
USB	USB 1.1/2.0 compatible
Serial	RS232
Parallel	IEEE 1284.4
Ethernet	10 Base-T/100 Base-TX compatible

2.7.1 Connecting USB Interface

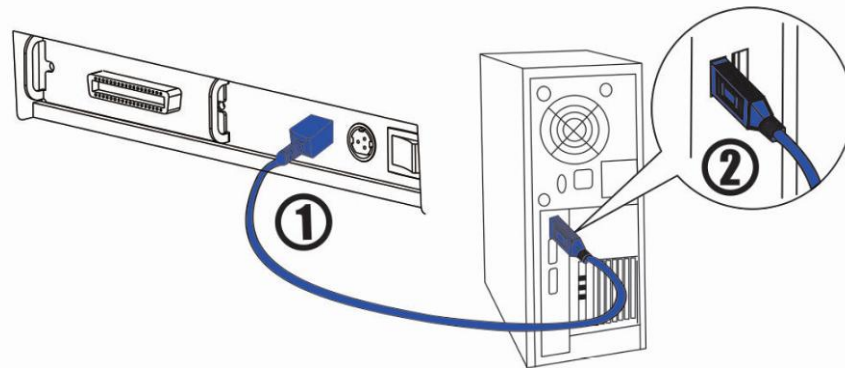

2.7.2 Connecting Serial Interface

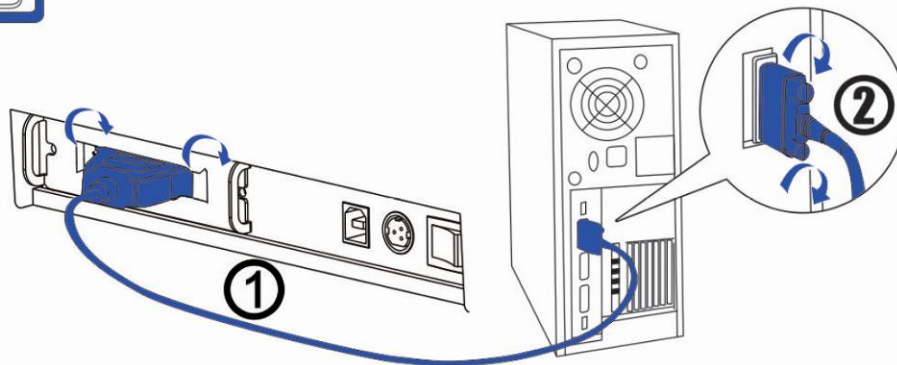
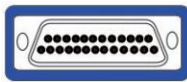

WARNING!

Be sure to turn off the power supply for both the printer and host computer before connecting the cables.

1. Insert the interface cable connector firmly into the interface connector on the connector panel.
2. When using the connectors equipped with screws, tighten them to secure the connectors firmly.

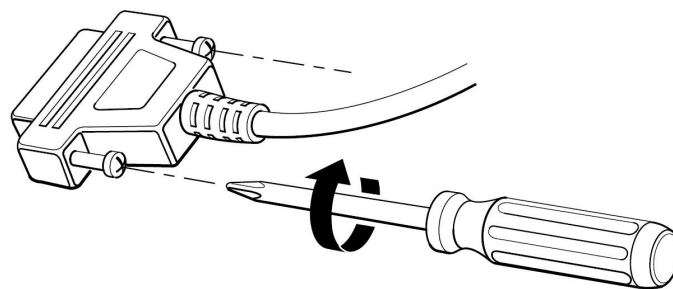

3. When using interface cables equipped with a grounding line, attach the ground line to the screw hole marked "FG" on the printer.
4. Connect the other end of the interface cable to the host computer.

2.7.3 Connecting Parallel Interface

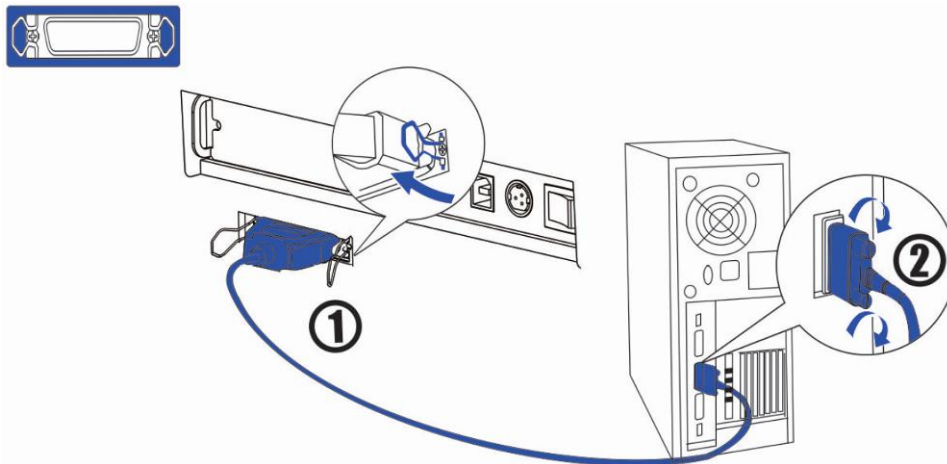

1. Insert the interface cable connector firmly into the interface connector on the connector panel.
2. Press down the clips on either side of the connector to lock it in place.
3. When using interface cables equipped with a grounding line, attach the ground line to the screw hole marked “FG” on the printer.
4. Connect the other end of the interface cable to the host computer.

2.7.4 Connecting Ethernet Interface

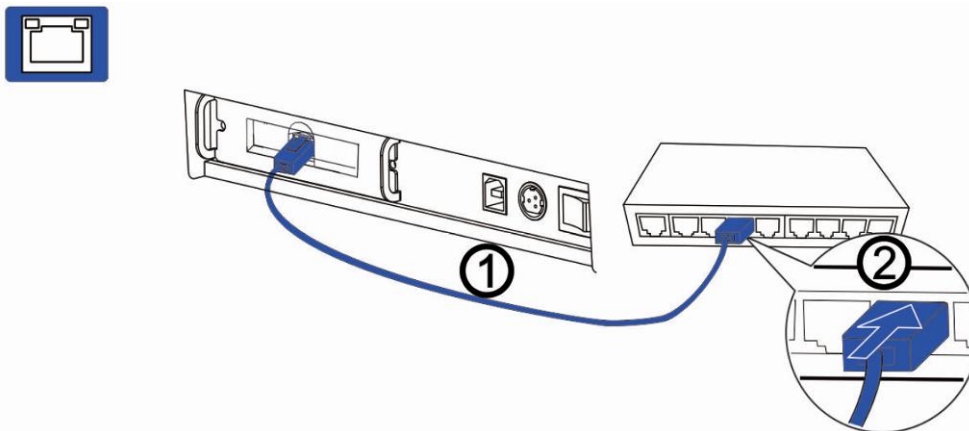

- Before installation, make you have installed the driver and the driver for Ethernet interface (see Installing Driver on page 17)
- When LAN cables are installed outdoors, make sure devices without proper surge protection are cushioned by being connected through devices that do have surge protection.



Otherwise, the devices can be damaged by lightning.

- Never attempt to connect the customer display cable, drawer kick-out cable, or the standard telephone line cable to the 10/100BASE-T LAN connector.

1. Connect the printer to a network by a LAN cable via a switch.
2. Connect a 10/100BASE-T cable to the 10/100BASE-T LAN connector by pressing firmly until the connector clicks into place.

2.7.5 Connecting Wlan Interface

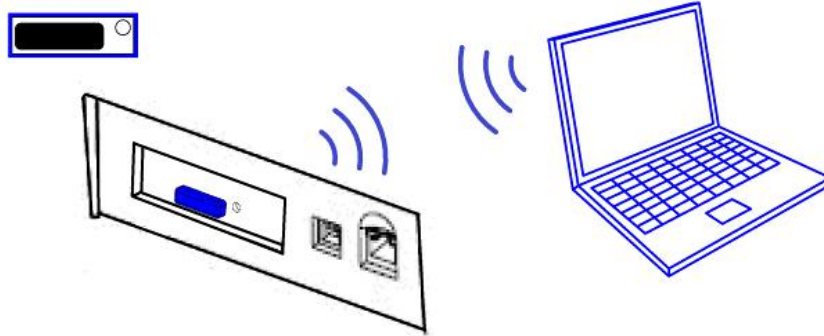

CHAPTER 3 NETWORK SETUP AND CONFIGURATION

3.1 Installing Driver

The driver is the connection and transformation platform between the printer and the computer operating system to achieve the interactive processing of the information. User can set up relevant settings, get print status and etc. via driver.

The latest Windows printer drivers can be downloaded from our web:

<https://www.dascom.com/downloads.html>

From the folder that you unzipped the driver files to select “Install.exe”. The program will guide you to finish the whole installation.

(1) Click “Next”.



(2) Select the driver model and a port, Click “Next” button to continue.

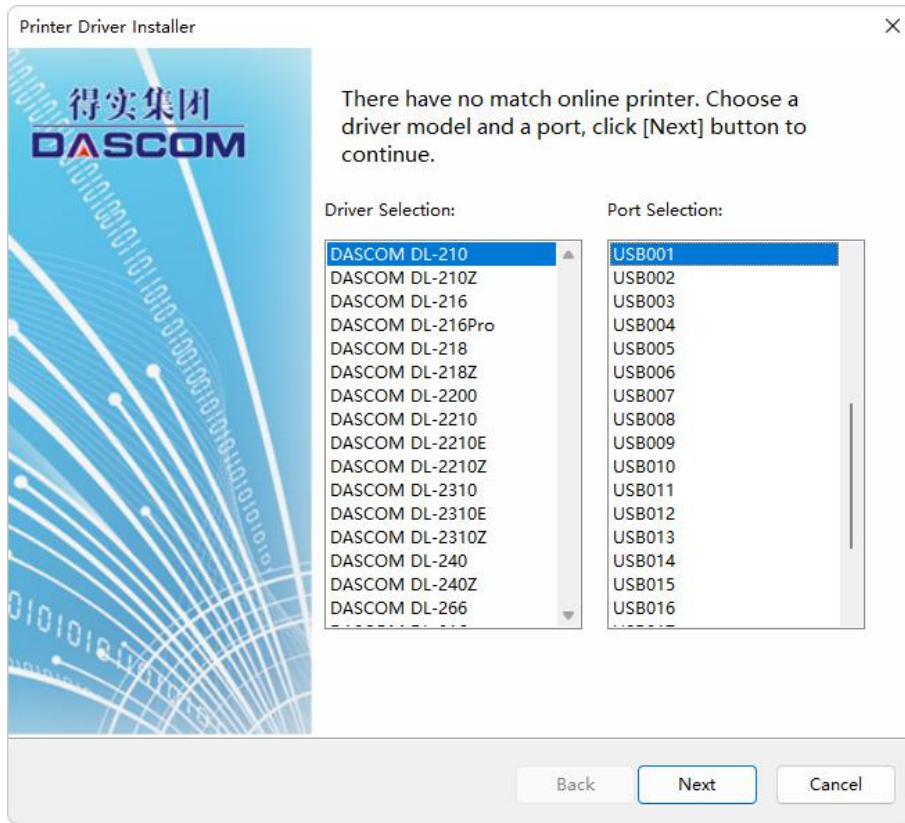

(3) Set up the printer name, click “Start”.

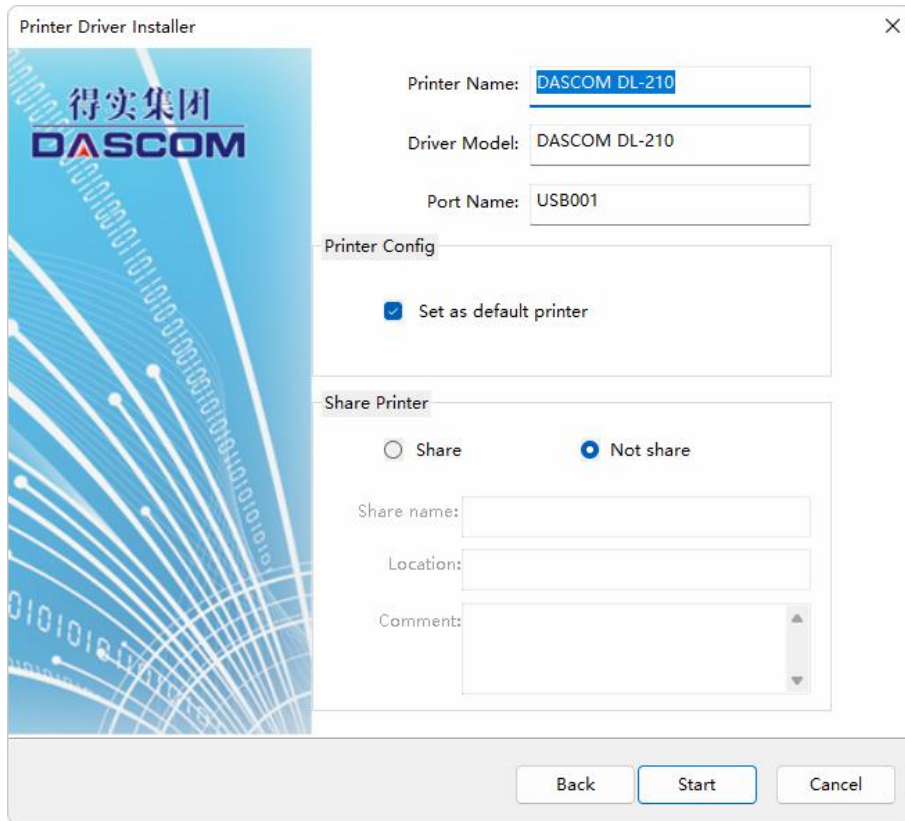

(4) Wait for the installation to finish.

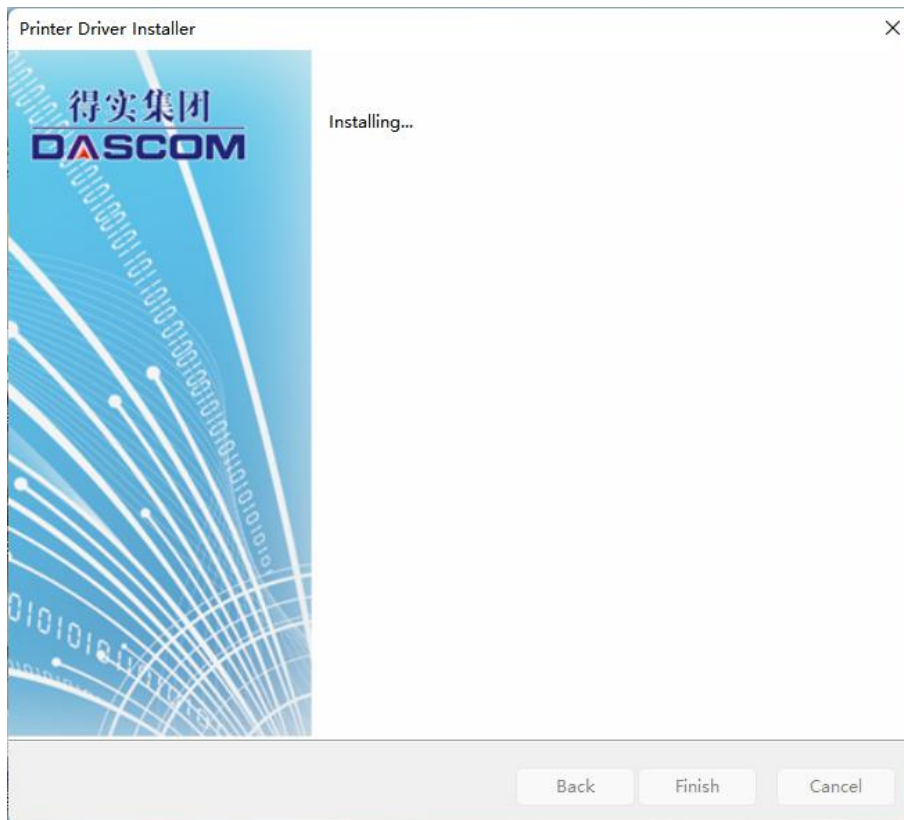

(5) Click the Finish button once the installation ends.

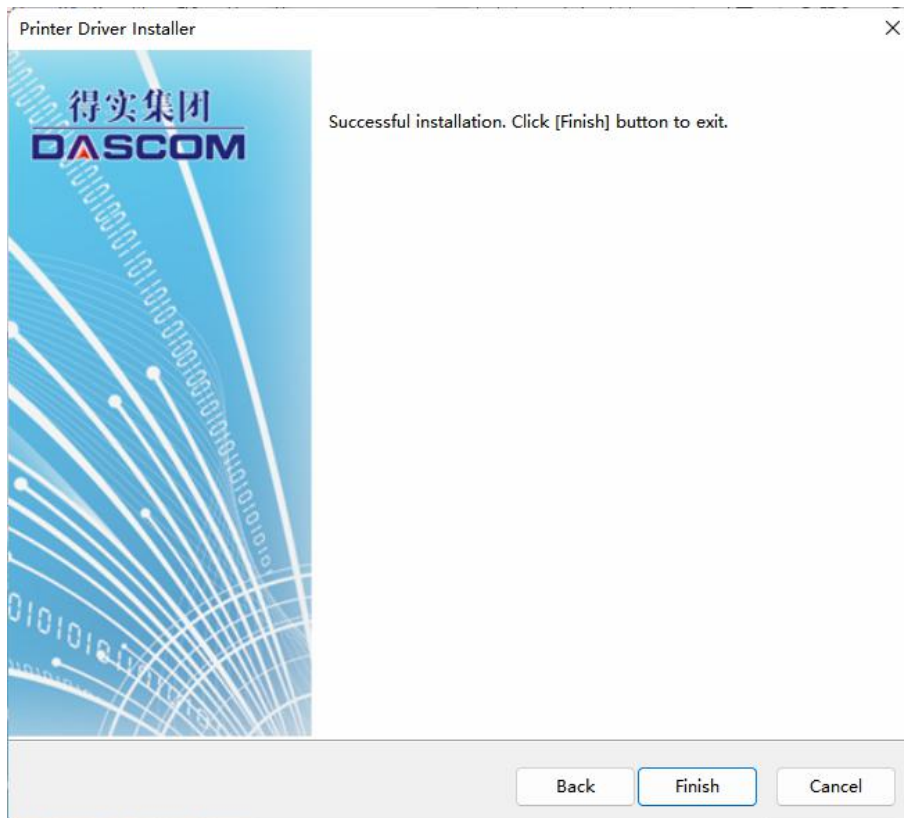

3.2 Installing Setup Tool

The Configuration Tool package can be downloaded from our web:

<https://www.dascom.com/downloads.html>

- (1) Choose setup language.

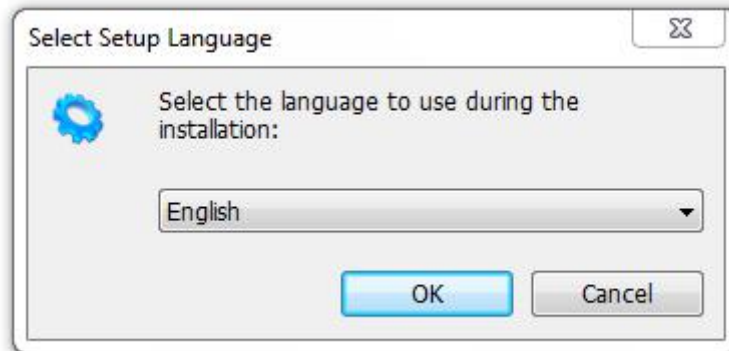

- (2) Click next.

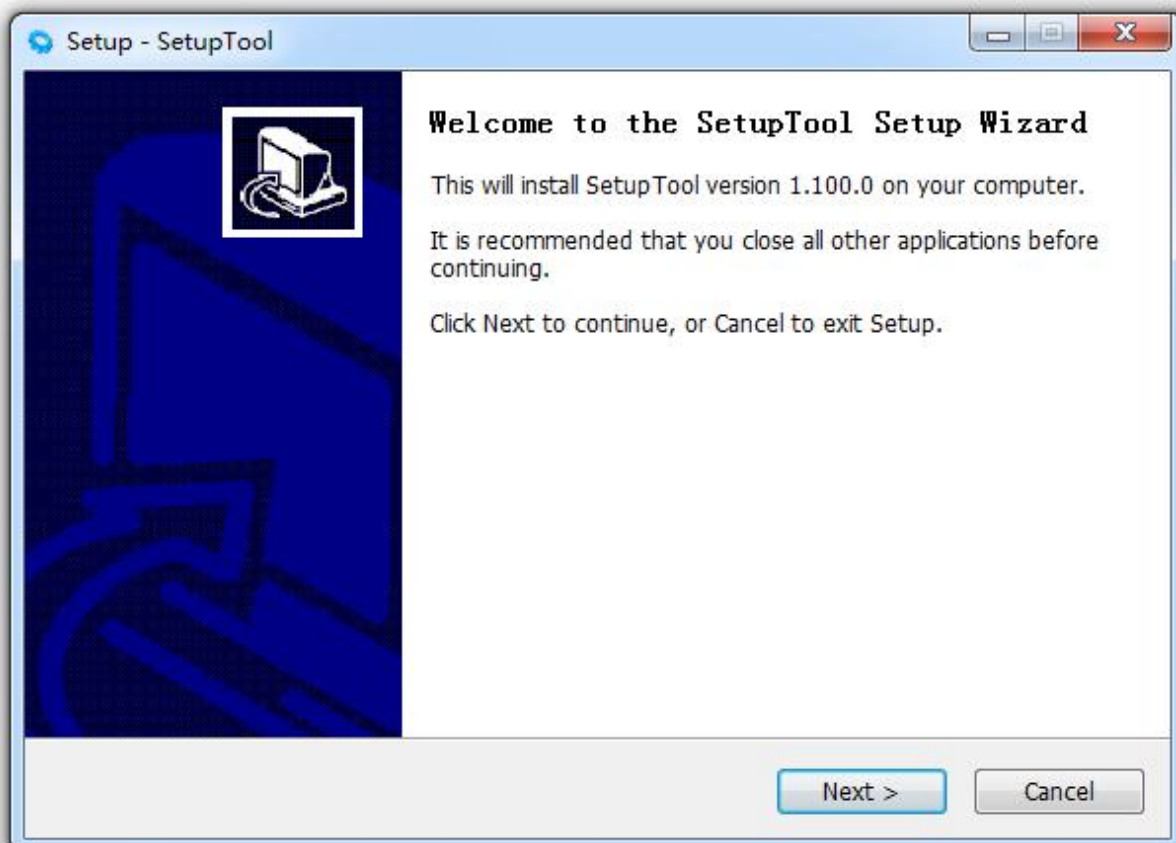

(3) Select the installation path to the tool.

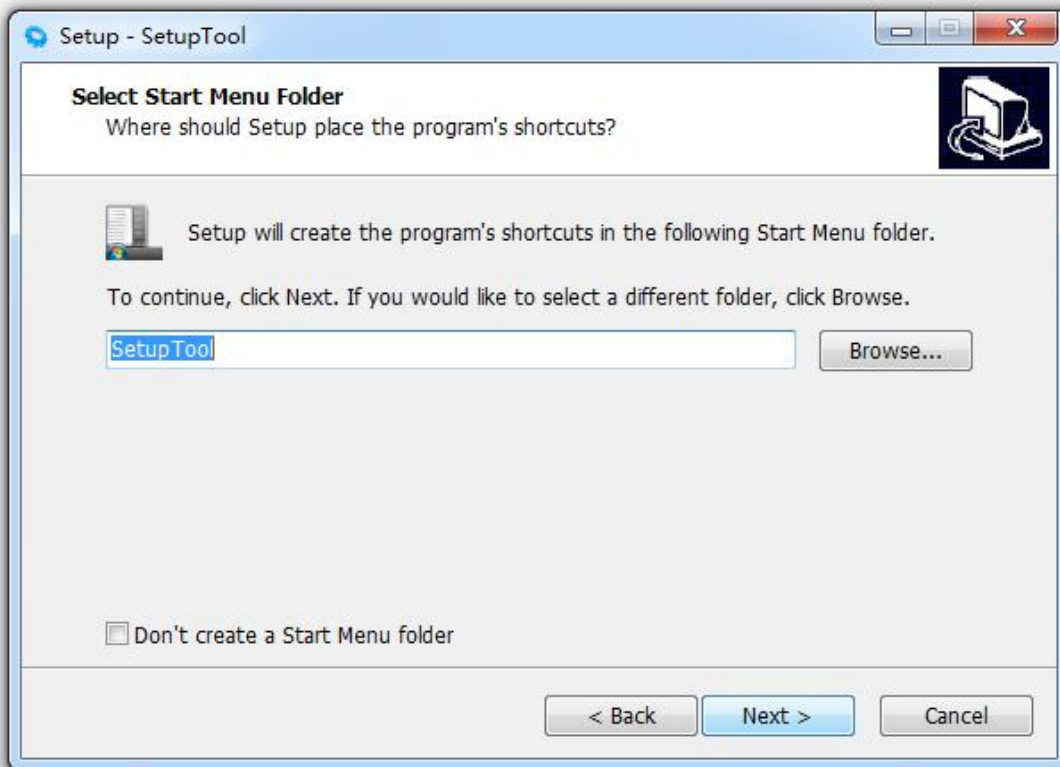

(4) Click "Finish".

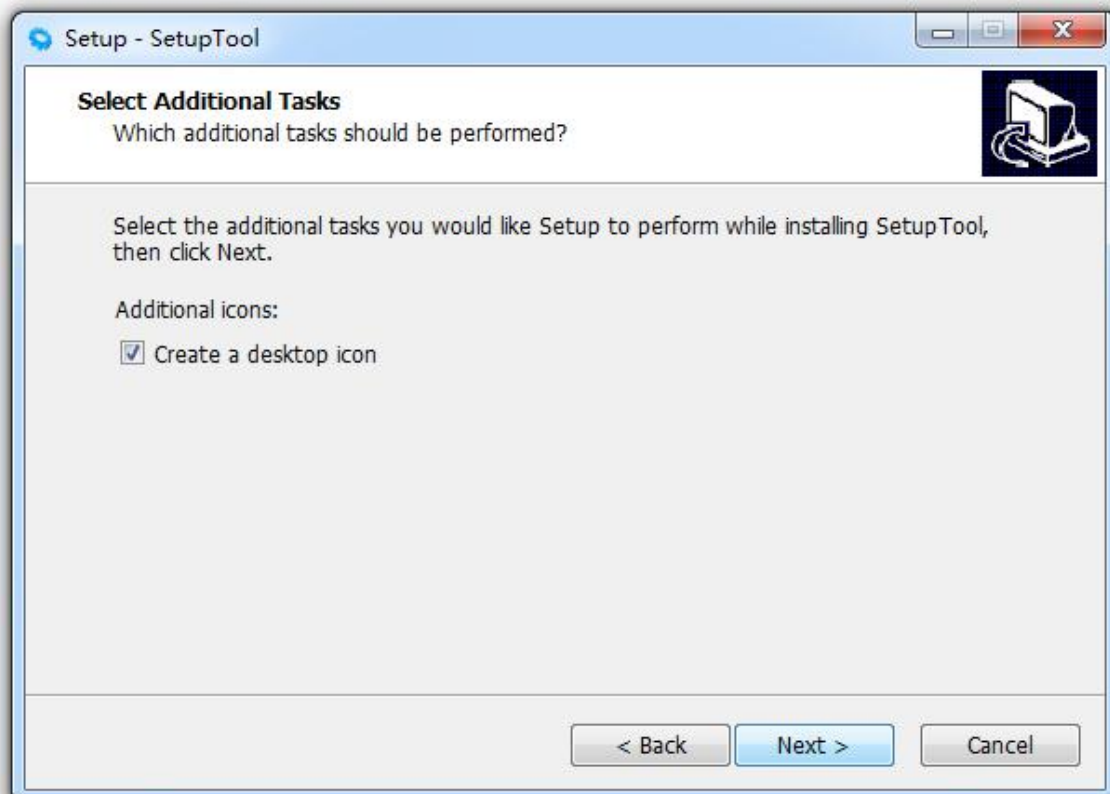

(5) Click "Install".

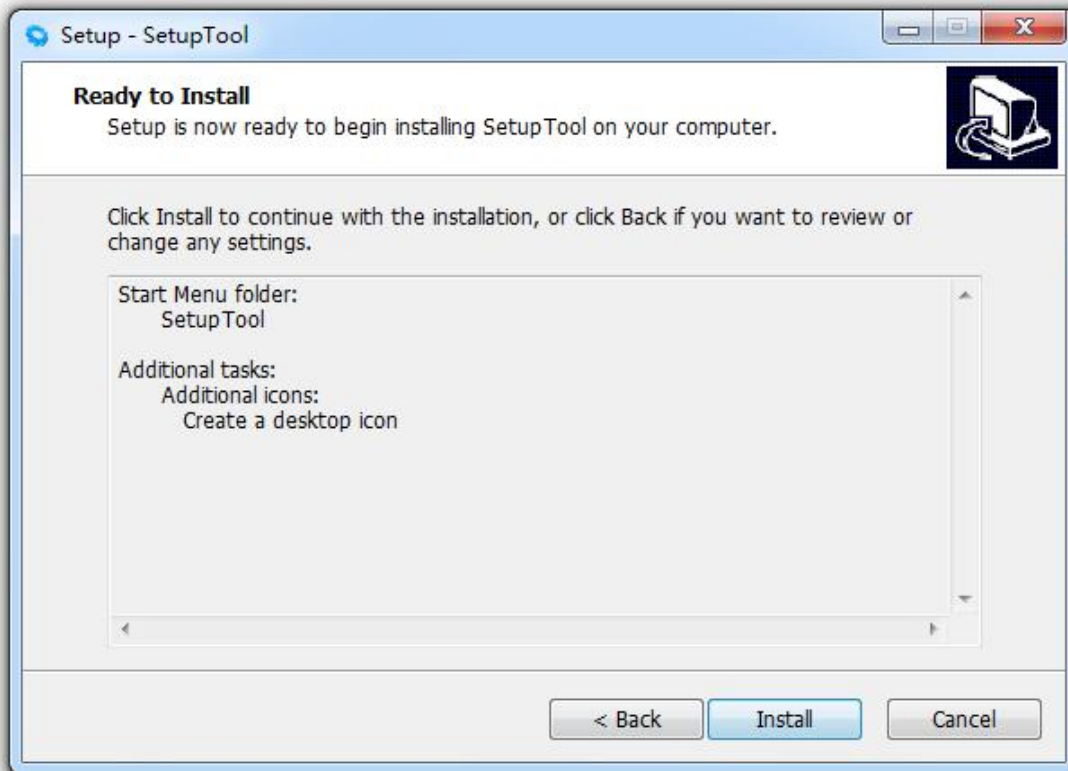

(6) Wait the installation to complete.

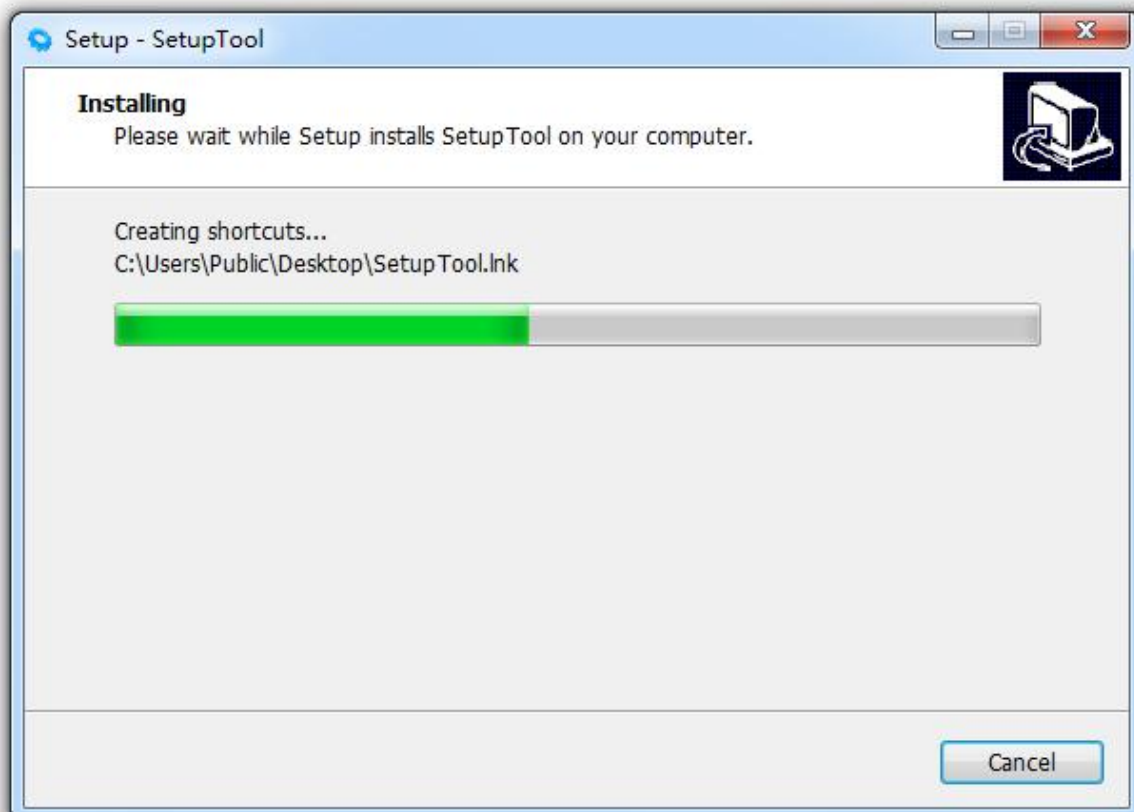

(7) Installation complete. Click "Finish".

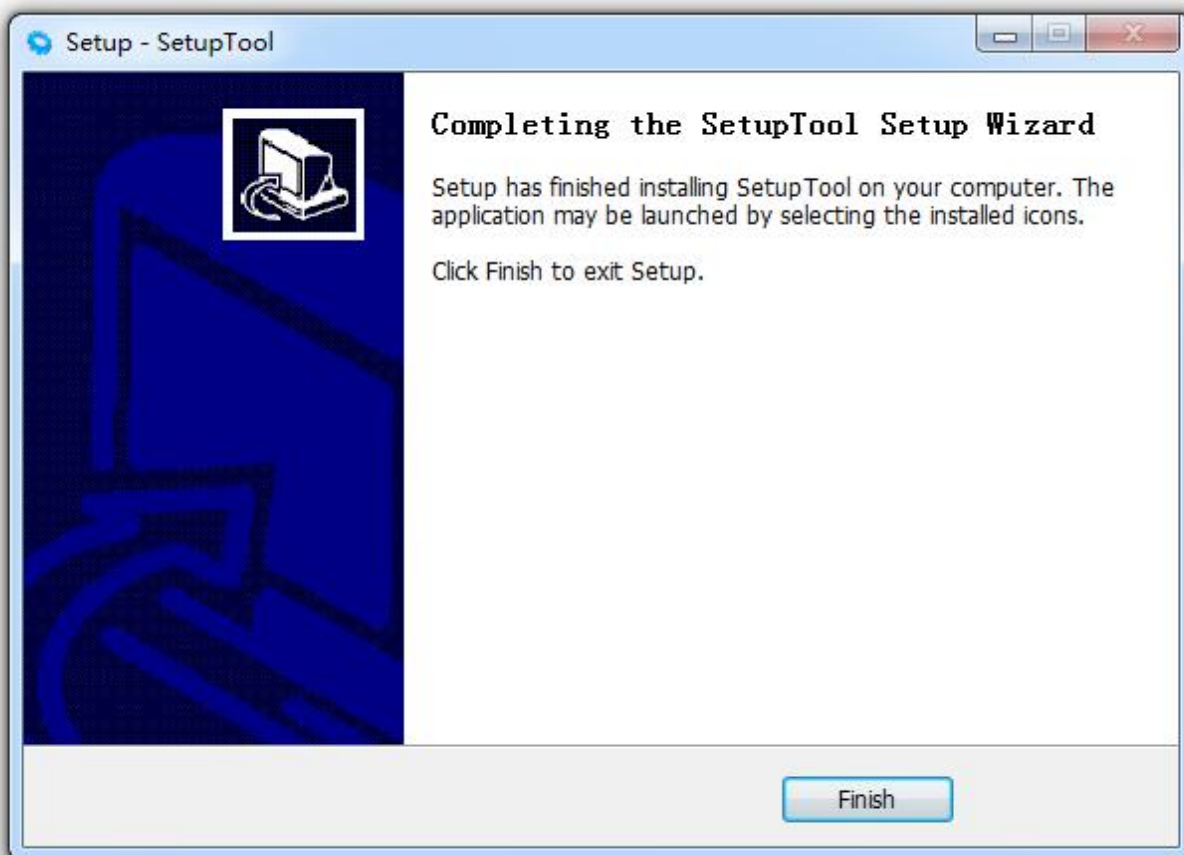

3.3 Setup Tool Application

POS & label printer setup tool can be downloaded from our web:

<https://www.dascom.com/downloads.html>

Read the help file carefully before using the setup tool. Please click “Help” button below for more information.

3.3.1 Model and Interface Setting

Select the printer model and the suitable interface before configuring printer.

Click “setting” for setting serial interface or parallel interface. For serial interface and emulation setting, the setting won’t be valid unless you restart the printer.

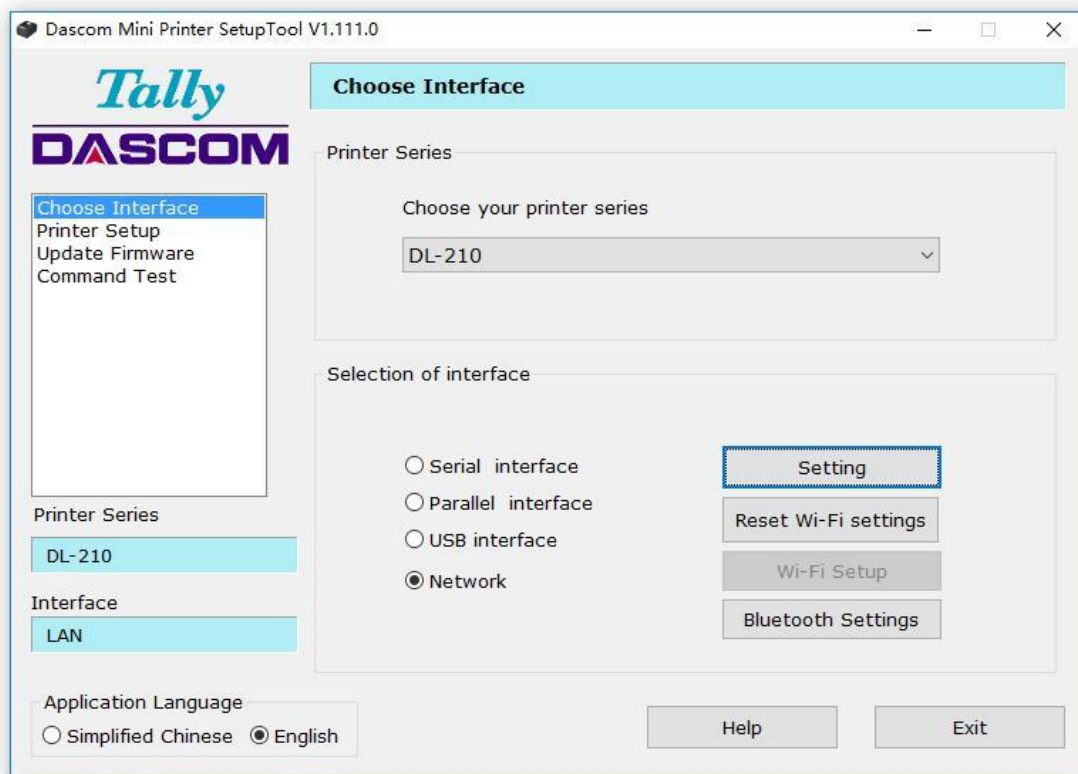

3.3.2 Configuring Printer

After model and interface setting, select “Printer Setup” tab for configurations.

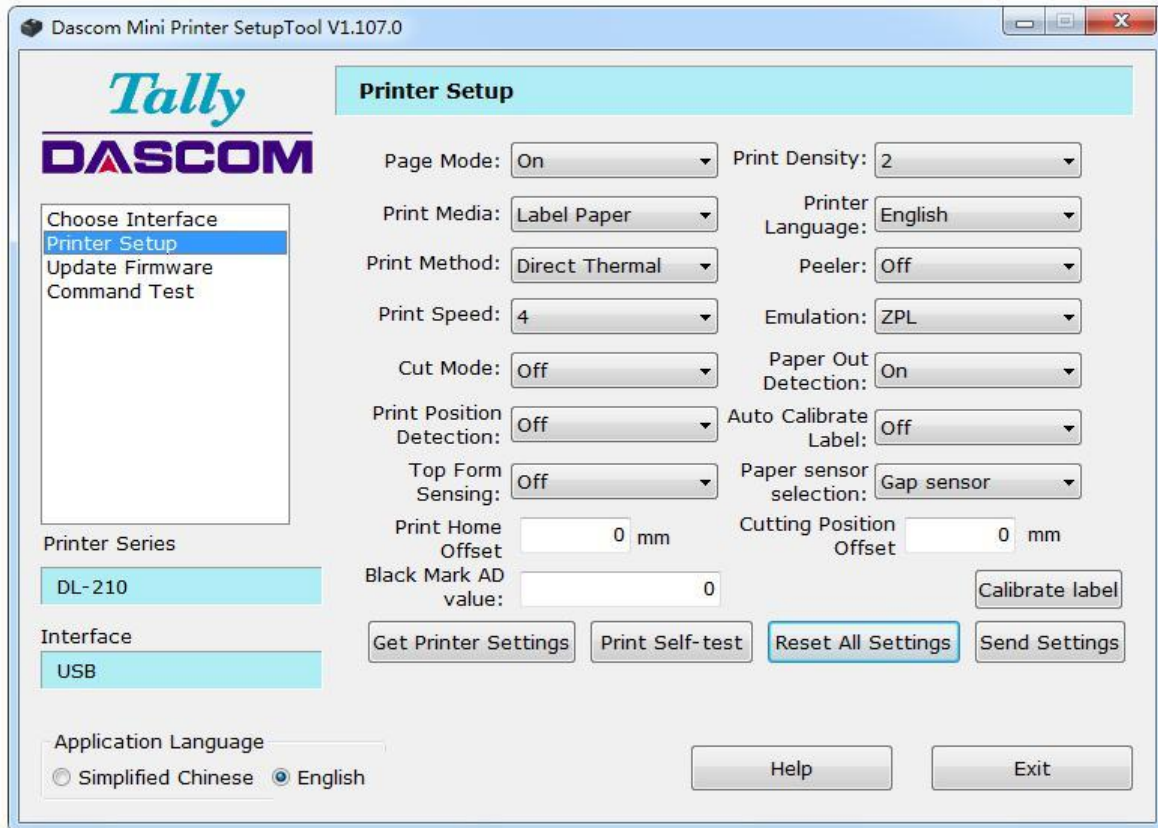

➤ Setup Items Explanation

Setup Items	Options	Default	Description
Page Mode	On, Off	On	Use un-continuous paper set to on; Use continuous paper set to off.
Print Density	1, 2, 3, 4, 5, 6	2	Adjust print density. Level 1 is lowest, Level 6 is highest.
Print Media	Label Paper, Continuous Paper	Label Paper	Select the actual media type.
Printer Language	English, Chinese	English	Set the printer's system language, Chinese or English.
Print Method	Thermal Transfer, Direct Thermal	Thermal Transfer	Use ribbon select thermal transfer; Use thermal paper select direct thermal
Peeler	Off, On	Off	Enable peeler or not
Print Speed	1, 2, 3, 4	4	Adjust the print speed. Level 1 is lowest, Level 4 is highest.
Emulation	ZPL, EPL, TSPL	ZPL	Select ZPL/EPL while using un-continuous paper; Select ESC/POS while using continuous paper.
Cut Mode	Off, Full Cut, Partial Cut	Off	Set the printer's cutting mode.
Paper Out Detection	On, Off	On	On: Detect the printer's paper is empty or not. Off: Disable paper end detection.

Print Position Detection	On, Off	Off	Enable print position detection or not
Auto Calibrate Label	On, Off	Off	On: It will auto calibrate the label when you use a different size/format of label. Off: Disable auto calibrate label
Top Form Sensing	On, Off	Off	Before the printer begins to detect the label length, it will feed and print based on the printing data so as to avoid unnecessary waste of media during length detection.
Paper Sensor Selection	Gap sensor, Reference sensor	Gap sensor	Choose between the gap sensor and the reference sensor.
Print Home Offset	User-defined	0	Set the vertical distance between print home position and the top of black mark. When the value is positive, the media moves inward towards the printer, and vice versa. Range: -5~+5 (mm)
Cutting position offset	User-defined	0	Set the vertical distance of the tearing position. When the value is positive, the media moves inward towards the printer, and vice versa. Range: -5~+5 (mm)
Black mark AD value	User-defined	0	Adjust the black mark detection accuracy.

➤ **Explanation for Buttons**

Button	Description
Get Printer Setting	When printer is powering on, click this button for acquiring the current setup menu. It will display on the screen.
Print Self-test	Click this button for printing current settings for the printer.
Restore All Setting	Click this button for restore to default setting.
Send Setting	Make the new settings effective.
Calibrate label	Click this button to calibrate label.



- After setting, the printer will beep once, then the setting become valid.
- In order to enhance print head lifetime, it is recommended that setting the low print density if the printing quality is acceptable.

3.4 LAN Interface Setup

(1) Select Network interface in the setup tool. Then click “Setting”.

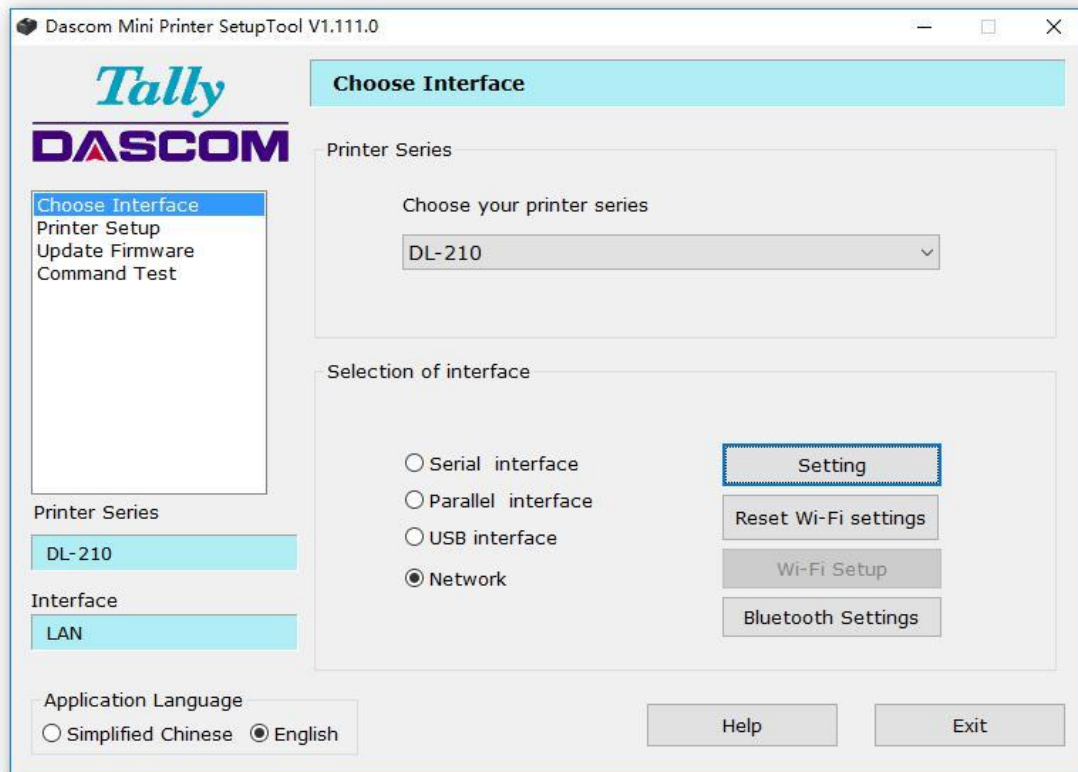

(2) Click “Setup Printer”.

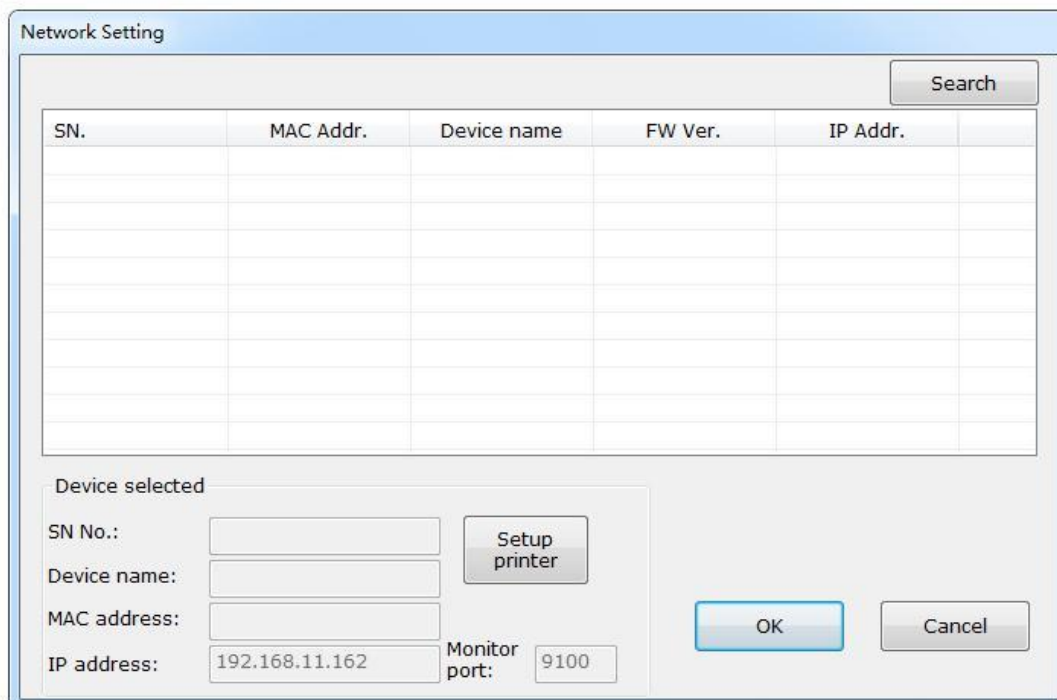

(3) You could change DHCP, IP address or other settings. Then enter OK.

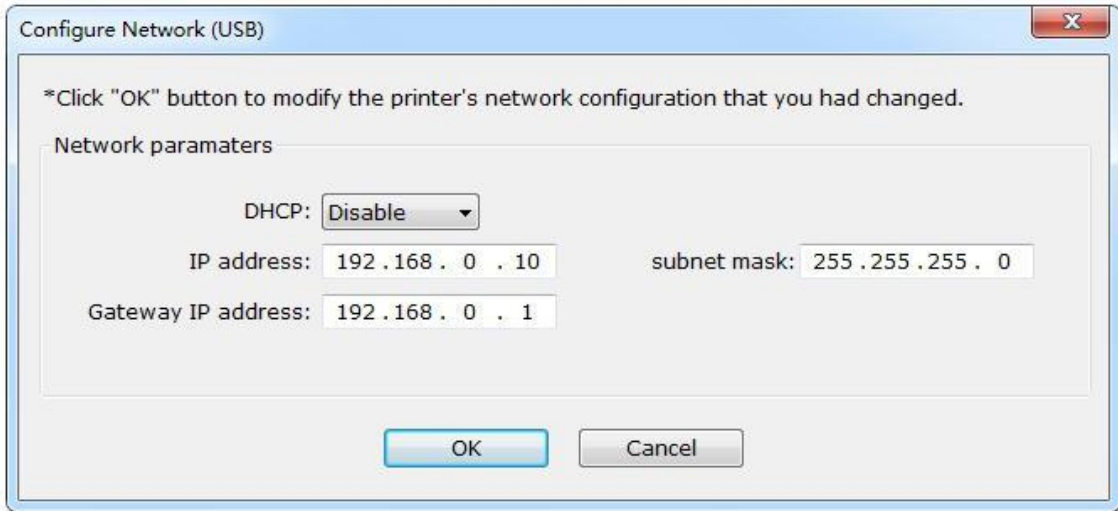

(4) At the end, click OK to implement the change.

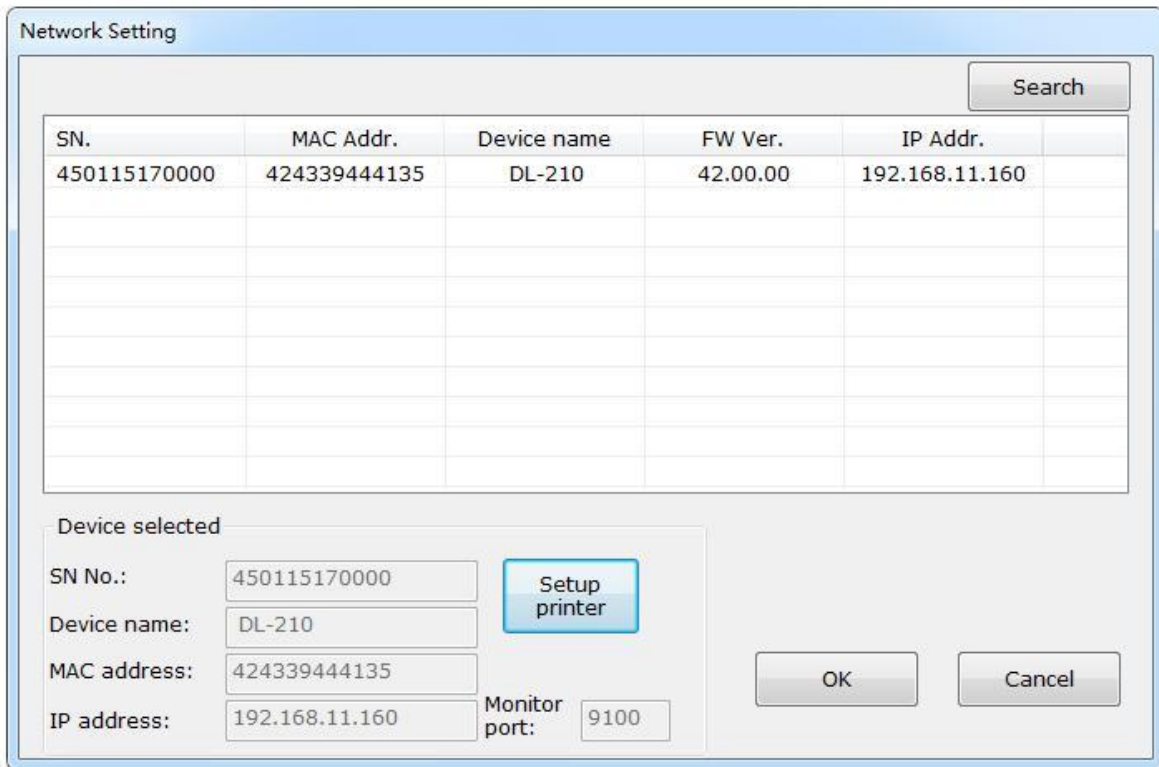

3.5 WLAN Interface Setup

If your printer needs to be connected to the computer via the Wi-Fi interface there are two basic modes of operation: AP mode and STA mode.

- AP means Access Point (AdHoc Mode). When the printer is working under AP mode, it receives information directly from the PC.
- STA means Station mode (Infra Structure Mode). When the printer is working under STA mode, communication through an access point serves as a bridge to other networks.

Initially the printer is factory set to AP mode; this is to ease to process of changing the printers Wi-Fi parameters. Users should use the setup tool to change the Wi-Fi parameters, such as IP address, network name, or switching to STA mode.

(1) Connect the PC to the printer with a USB cable. Turn on the printer.

Select USB interface in the setup tool. Then click “Wi-Fi Setup”.

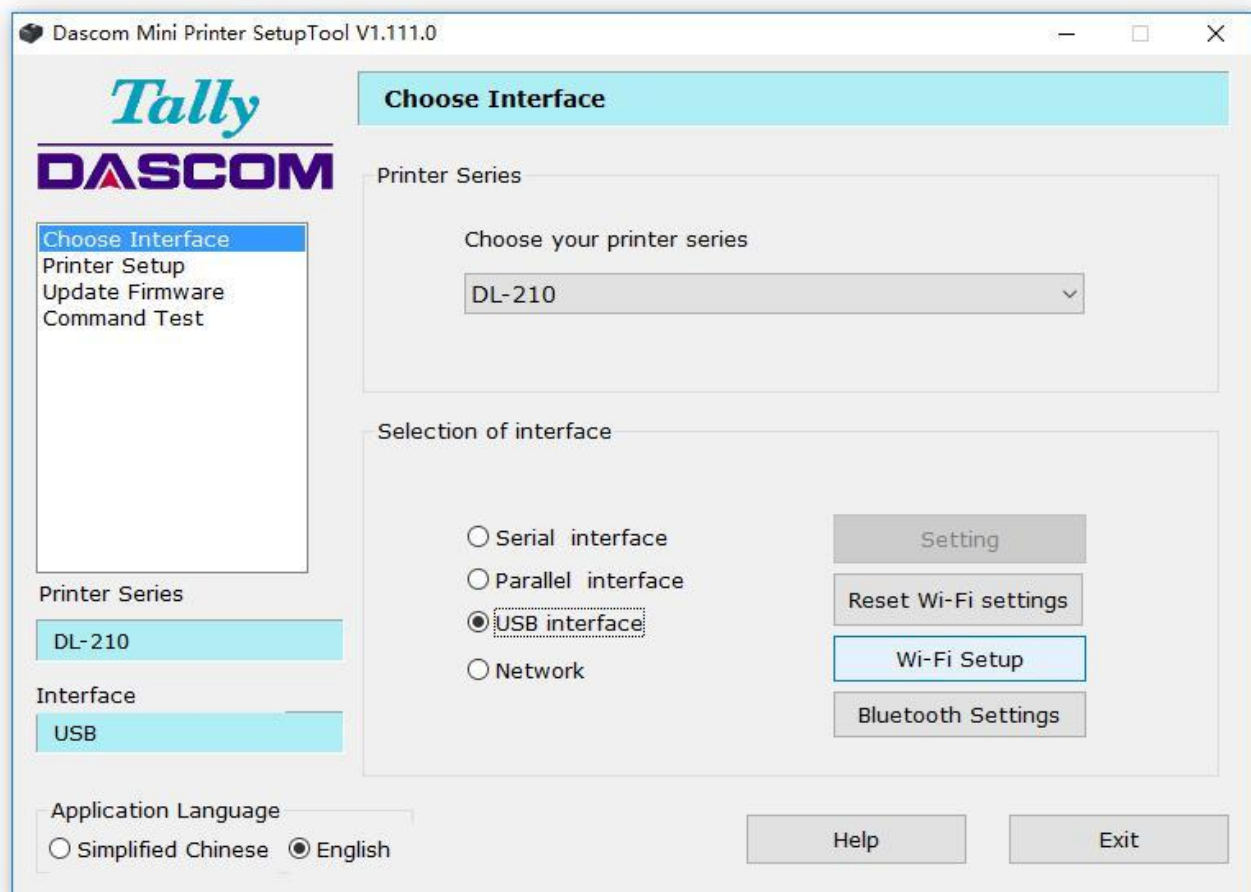

(2) You could change the working mode, SSID, DHCP, IP address or other settings. Then enter Confirm to save the new setting.

Wi-Fi Setup

Wi-Fi Mode:

SSID:

Encryption:

Key Format:

Key:

DHCP:

IP Address:

Subnet Mask:

Gateway:

KEY FORMAT INSTRUCTION:

1.None:Key not required;

2.WEP64:The key should be 5 ASCII characters or 5 hexadecimal digits;

3.WEP128:The key should be 13 ASCII characters or 13 hexadecimal digits;

4.WPA-PSK(TKIP) or WPA-PSK(CCMP/AES) or WPA2-PSK(TKIP) or WPA2-PSK(CCMP/AES):The key should be 8 to 63 ASCII characters or 8 to 64 hexadecimal digits.

3.6 Install Bluetooth Adapter Driver

(1) Make sure your PC is installed with printer driver (see chapter 3.1) and Bluetooth capable.

(2) Power on the printer and load the paper roll.

(3) Double click the Bluetooth icon  at lower right corner on the PC screen. You will see the following window then Click “Add a device”.

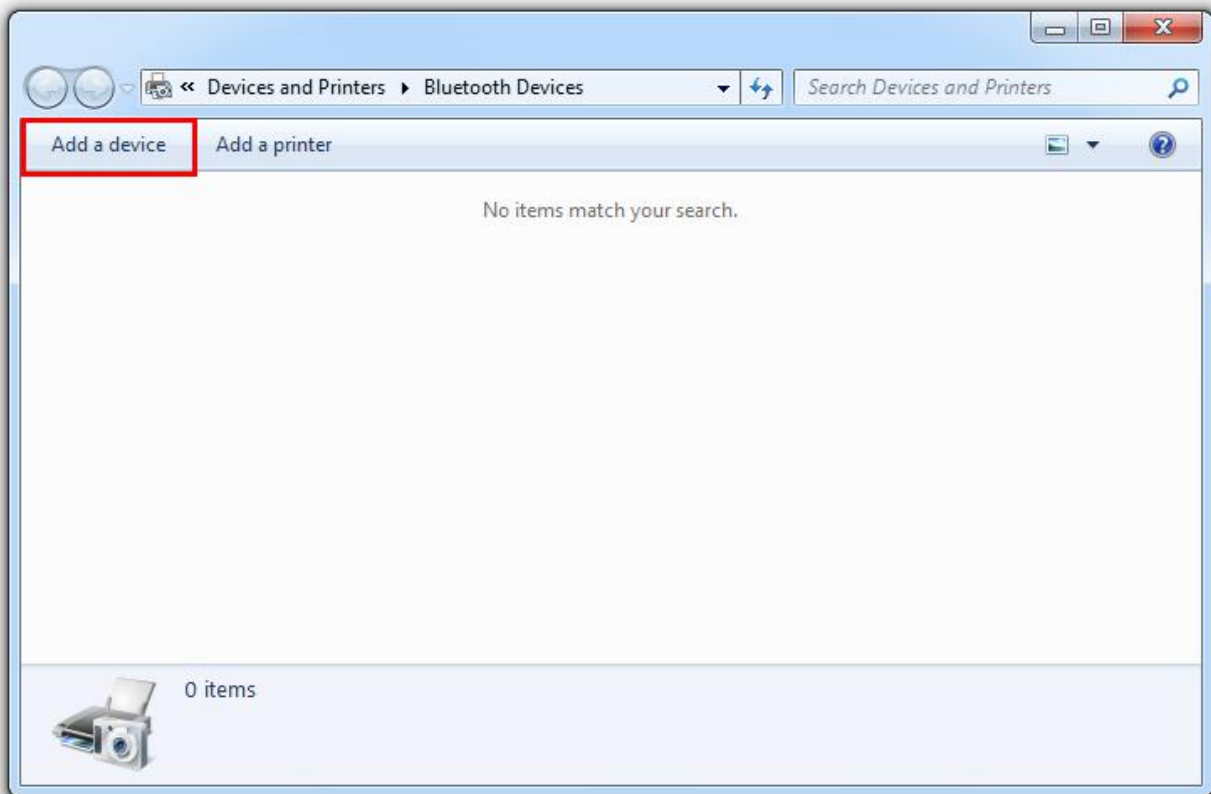

(4) Click the model name and press Next to continue.

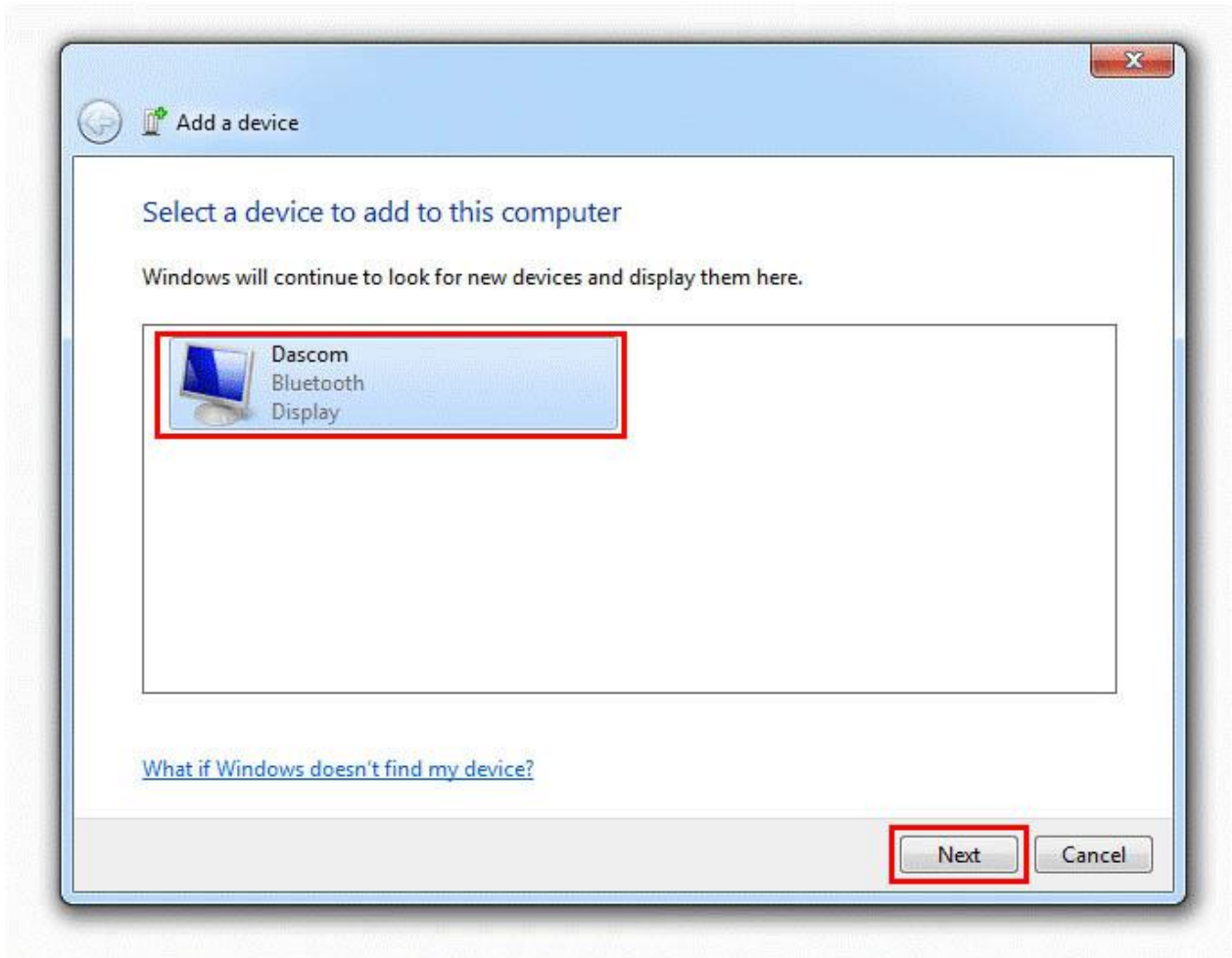

(5) Then the Bluetooth adapter is installed in the computer.

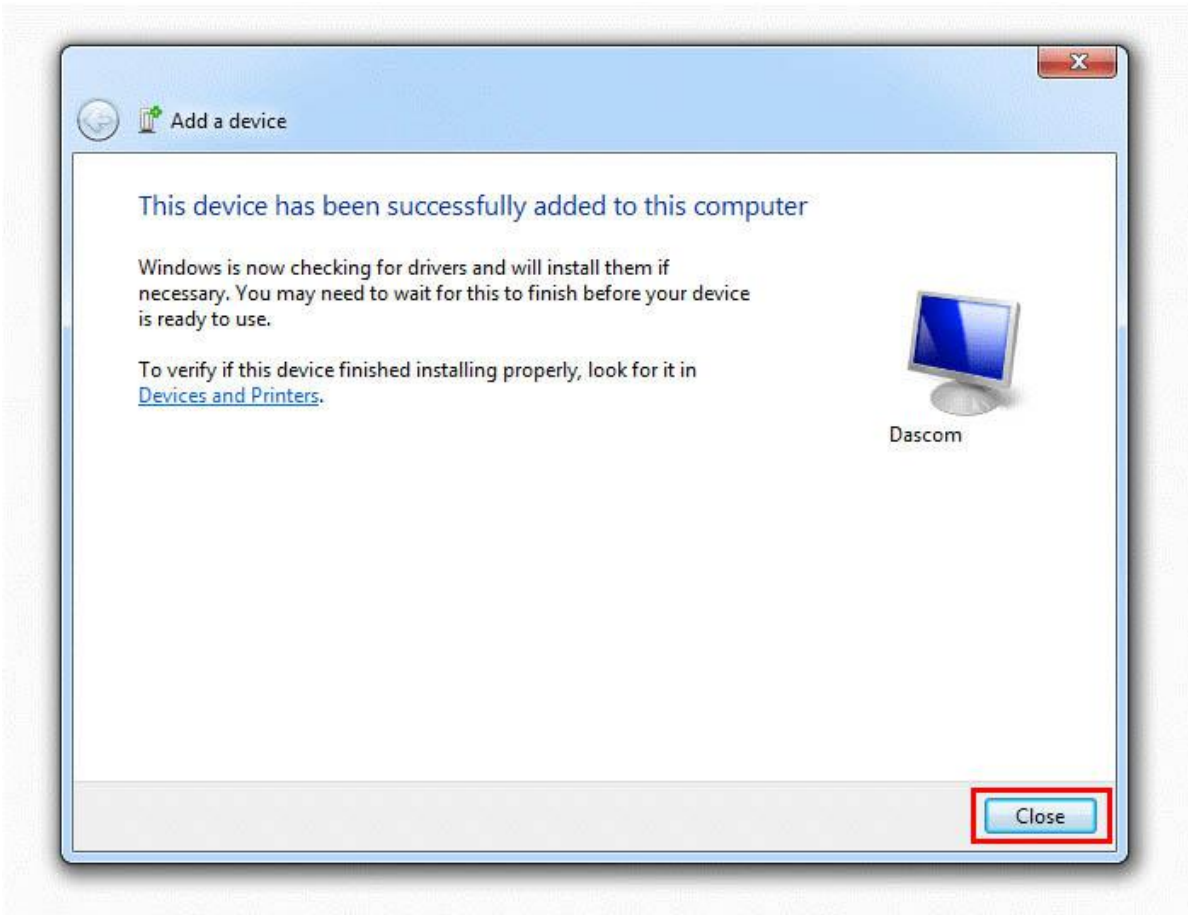

(6) Go to **Control Panel > Hardware and Sound > Devices and Printers > Devices**. Right click the printer, and then select **Properties**. Enter the **Properties** of the printer device.

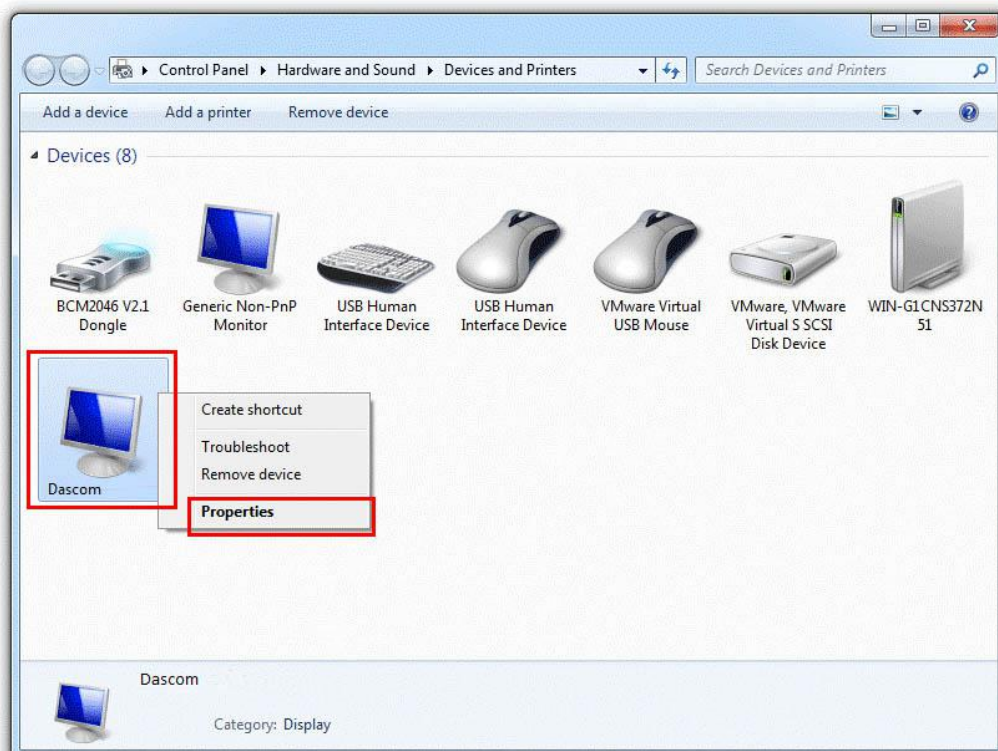

(7) Check the port type, in this case, it is COM4.

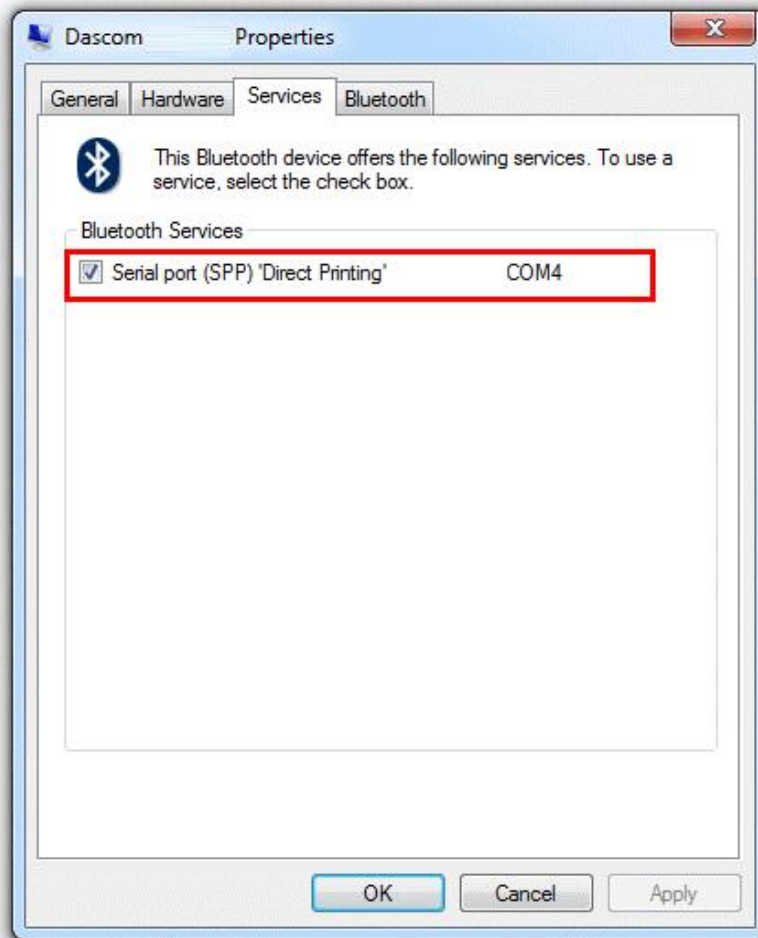

(8) Go to **Control Panel > Hardware and Sound > Devices and Printers > Printers**. Right click the printer, and then select **Printer Properties**.

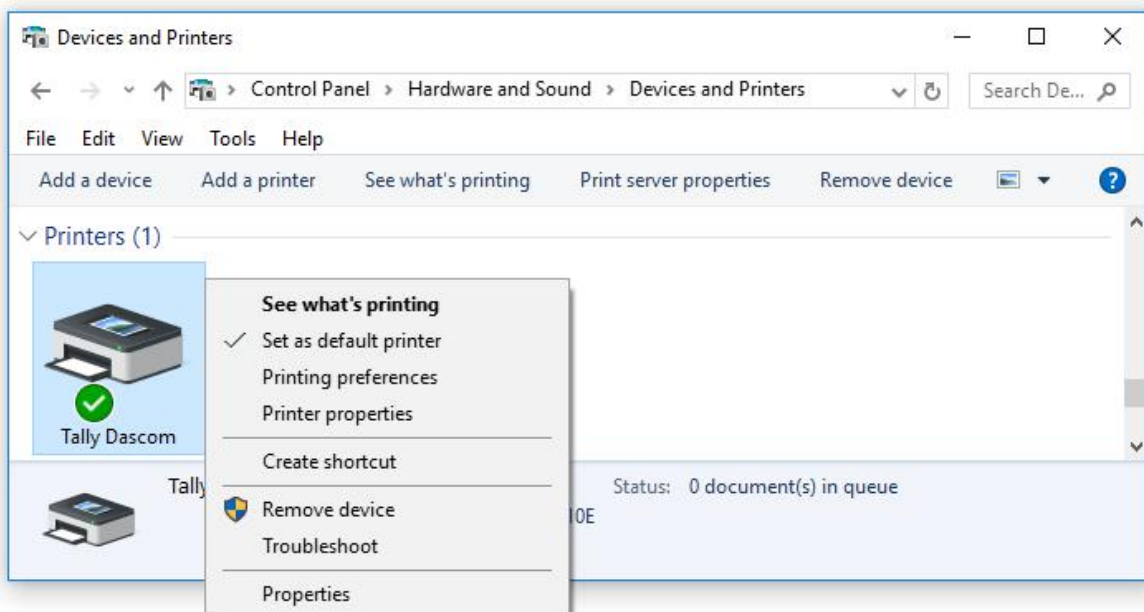

(9) Select the output port that you have put down (in the case COM4) then click **“Apply”**.

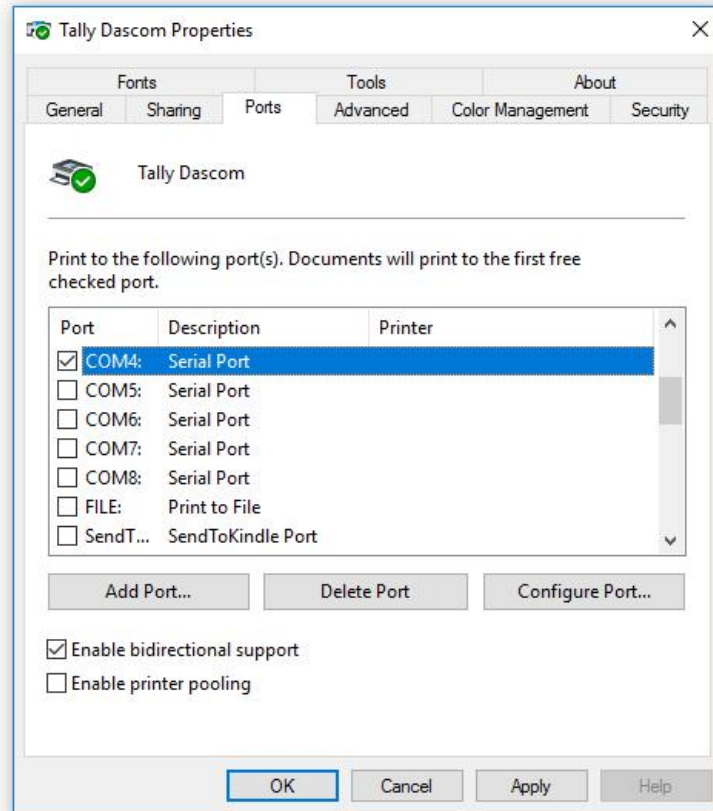

(10) Select **“General”** and click **“Print test page”** for checking Bluetooth performance.

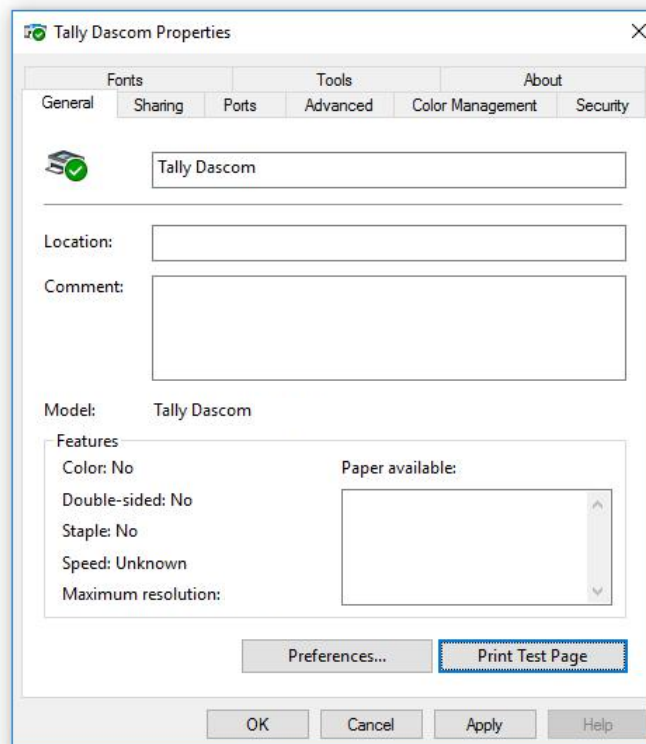

Setting pages vary depending on the different types of Bluetooth adapter.

3.7 Bluetooth Setup

(1) Select Network interface in the setup tool. Then click “Bluetooth Settings”.

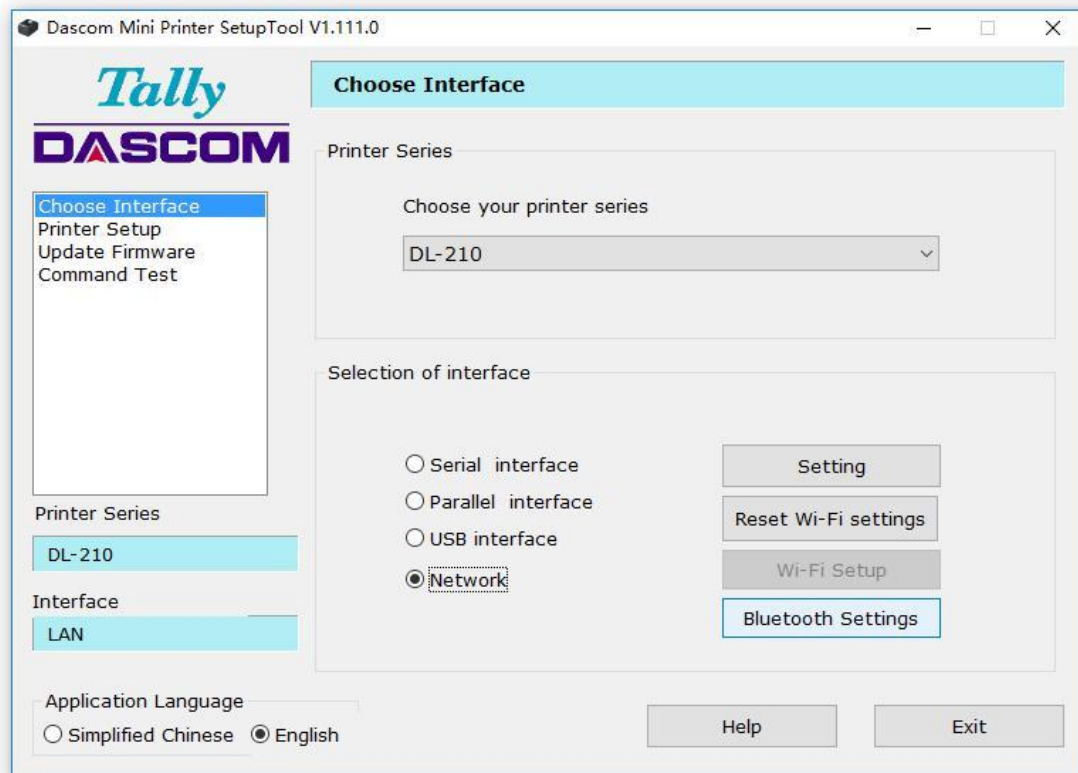

(2) Click Get Bluetooth Settings.

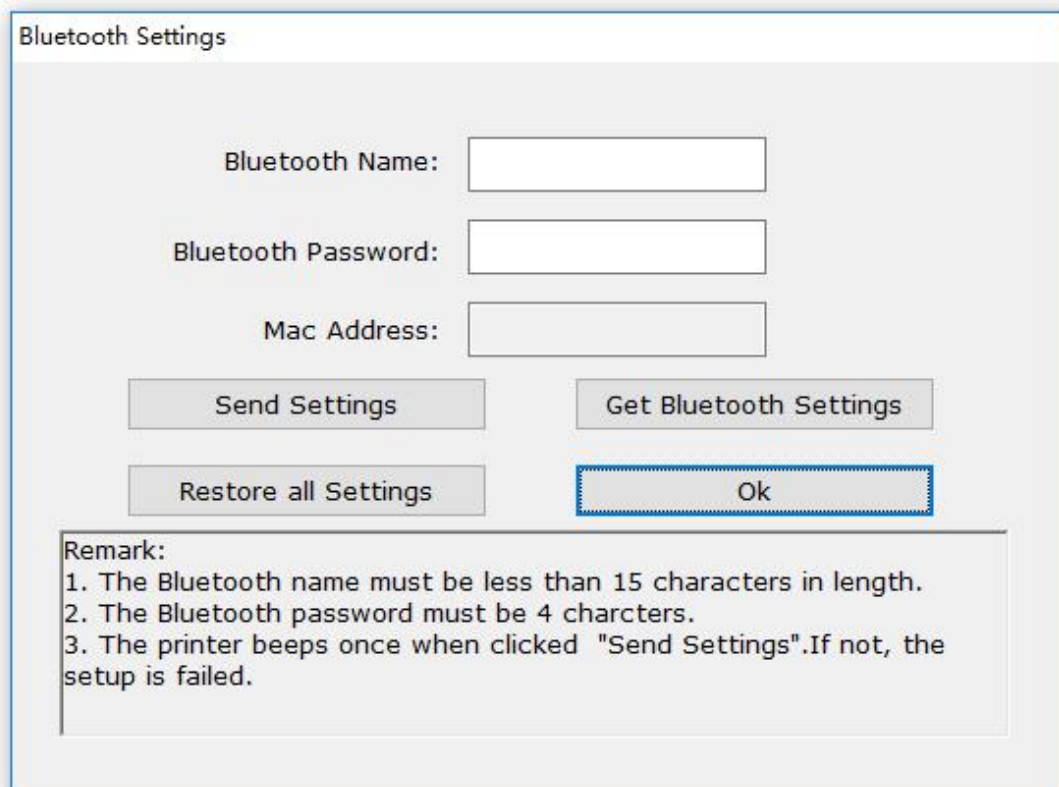

(3) You could change the Bluetooth Name and Password, and then click "Send Settings". Click "Ok" to quit the setup.

Bluetooth Settings

Bluetooth Name:

Bluetooth Password:

Mac Address:

Remark:

1. The Bluetooth name must be less than 15 characters in length.
2. The Bluetooth password must be 4 characters.
3. The printer beeps once when clicked "Send Settings". If not, the setup is failed.

3.8 Update Firmware



Dascom is not liable for any damage if customers are doing a firmware update by themselves. If power is switched off during the process, the printer may be damaged afterwards.

(1) Preparation

USB cable, 24V power adapter, DL-210 setup tool, firmware file.

(2) Connection

Connect printer and host with USB cable firmly. Check the Device Manager, if connection is successful, “USB printing support” will display under “universal serial Bus Controllers” directory. Otherwise, please check the connection between printer and USB interface, and also check whether the Driver installation is successful or not.

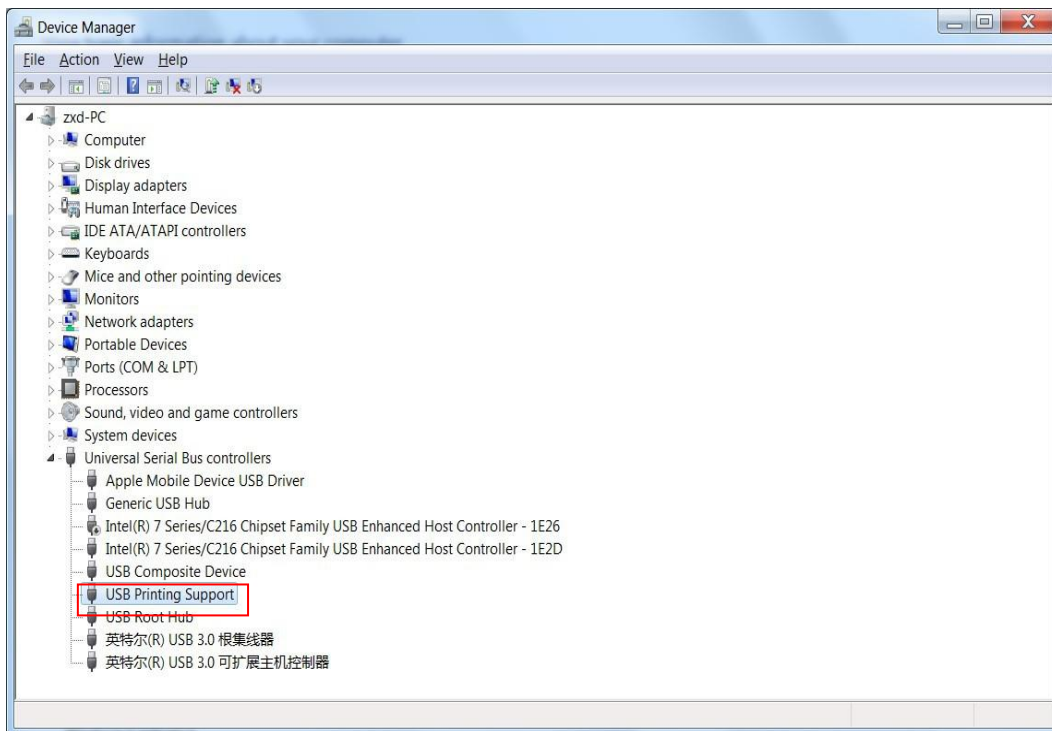

(3) Enter Update Mode

- ① Lift up top cover and turn up print head mechanism

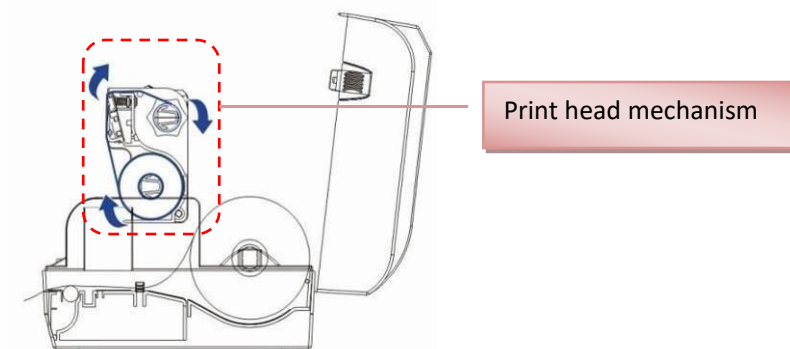

- ② Hold down Feed Button and switch on printer simultaneously. Release Feed Button once powering on, the printer beeps once.
- ③ If the Status LED is on, then the printer enters upgrade mode successfully.

(4) Upgrade Firmware

- ① Run Dascom setup tool, select model Label Printer and USB interface.
- ② Select “Update Firmware” tab, then click “Browse” to locate the firmware/CG file, and then click “Update”. This process may take up to 20 seconds.

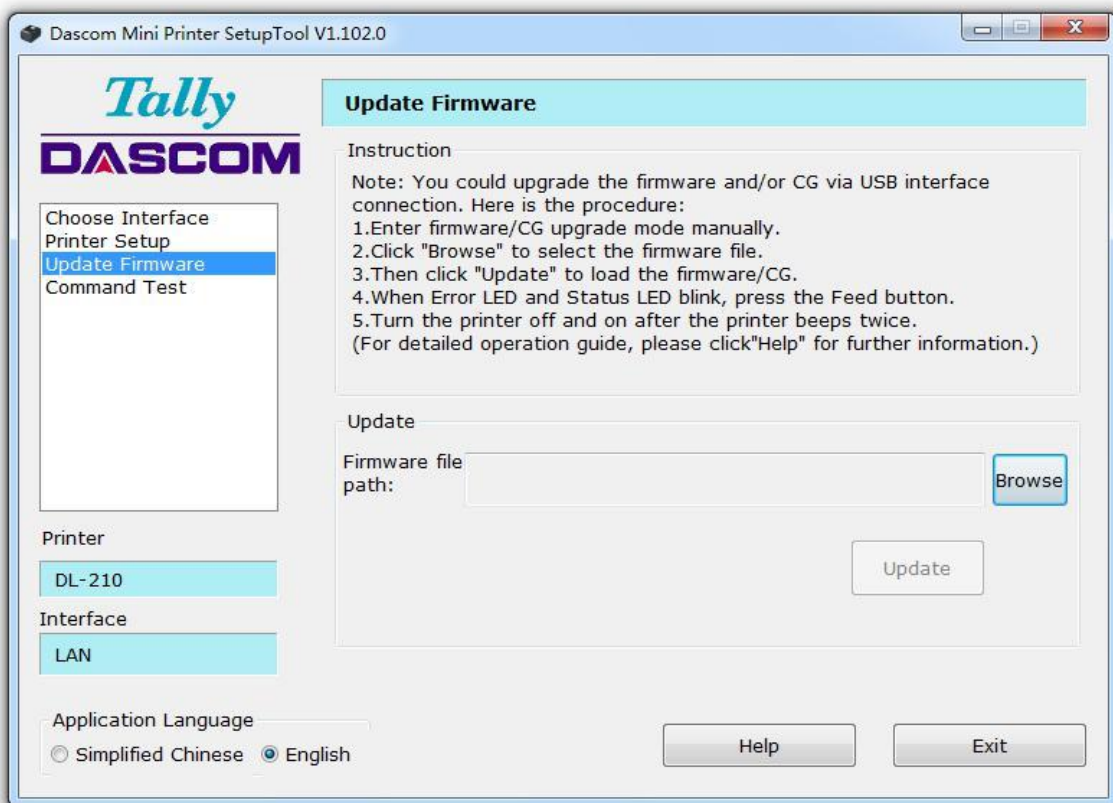

- ③ After loading the firmware, the Power LED, Error LED and Status LED should blink.
- ④ When the printer beeps twice, and the three LEDs are on, turn the printer off.
- ⑤ Firmware updated successfully.

3.9 Cutter and Peeler Setup (Option)

- **Cutter Setup**

(1) If the printer has the Cutter Option installed, switch “Cut Mode” parameter in “Printer Setup”, within the Setup Tool , to On before operation.

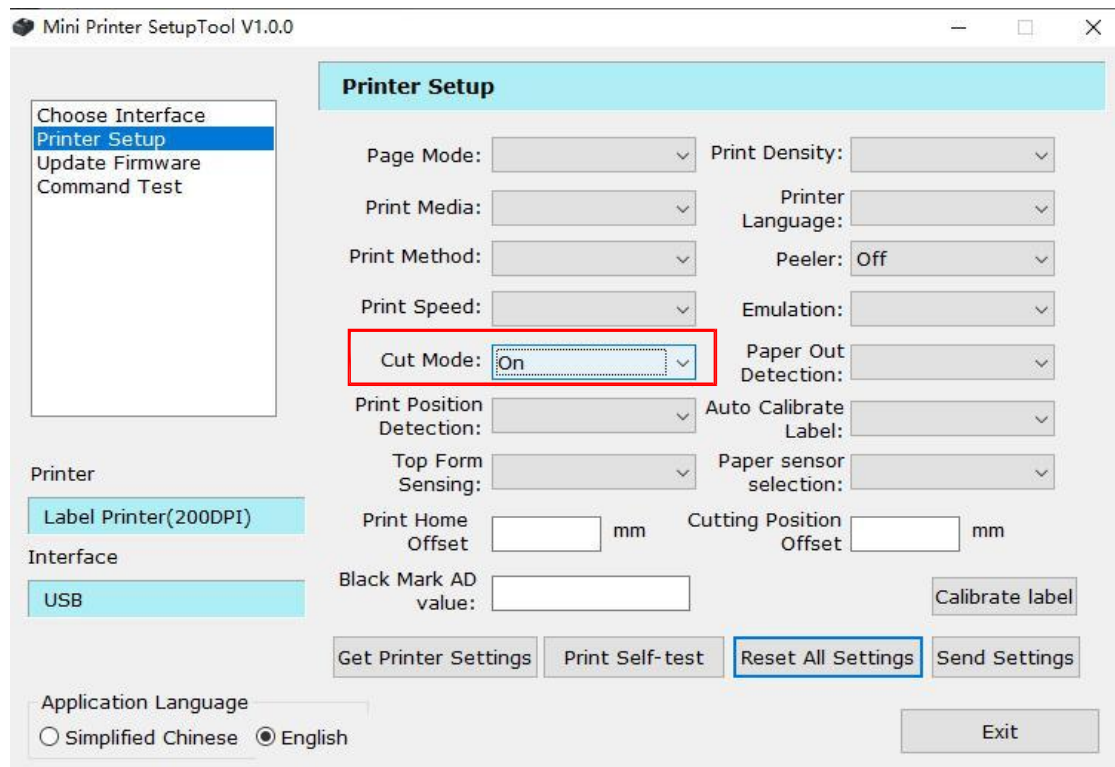
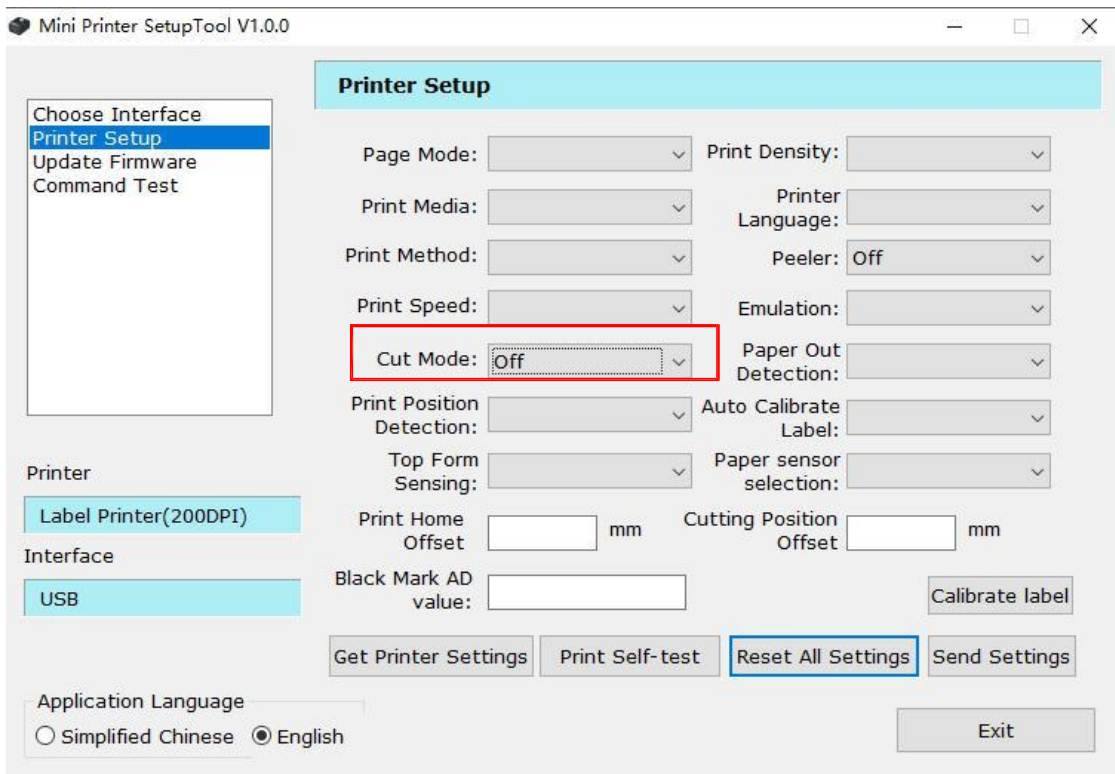

● Peeler Setup

(1) If the printer has the Peeler Option installed, switch “Peeler Mode” parameter in “Printer Setup” , within the Setup Tool , to On before operation.

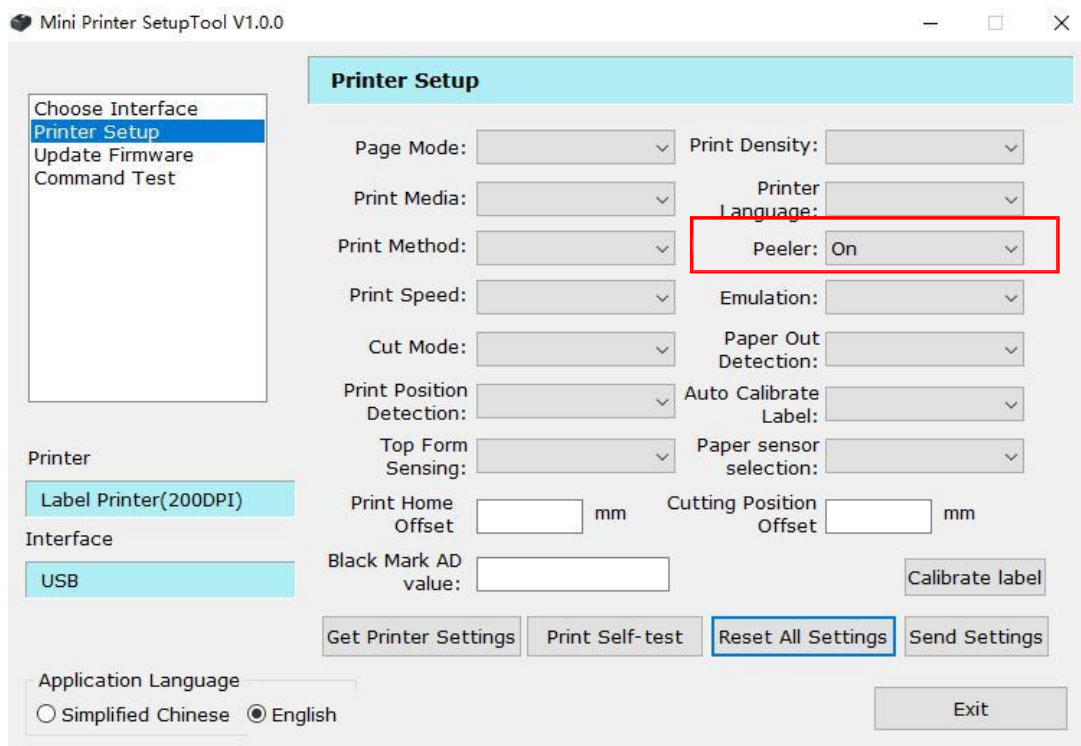
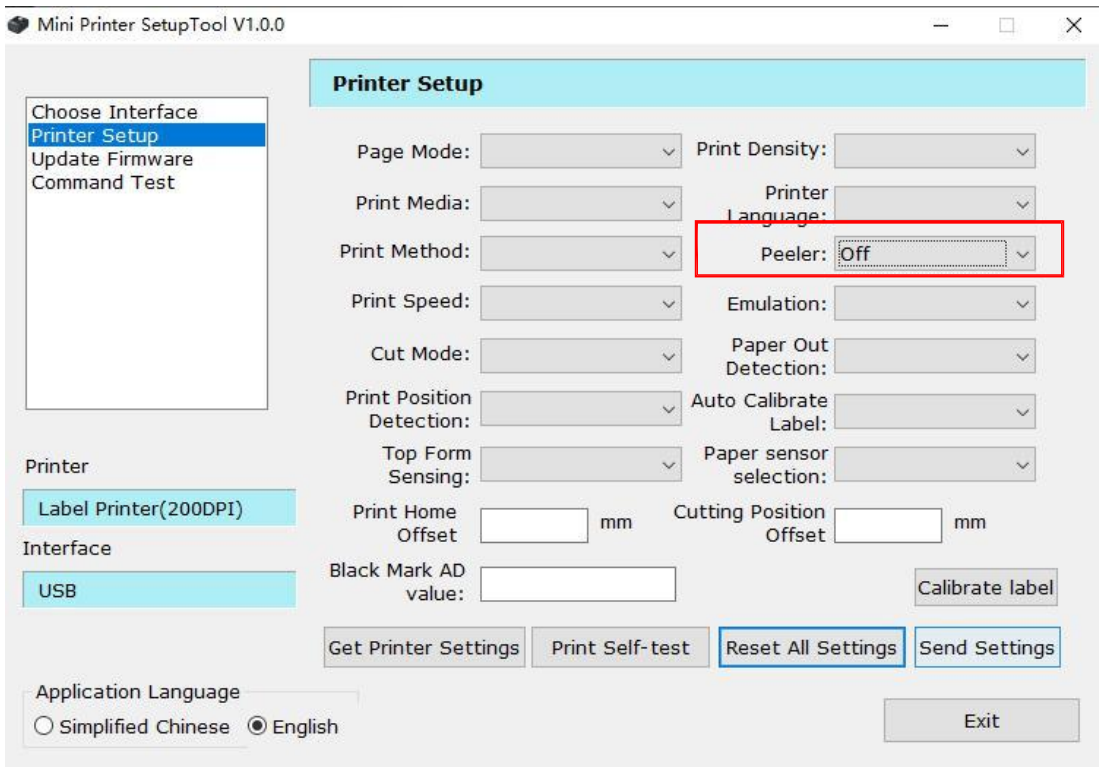

CHAPTER 4 SETTING/CHECKING MODES

Besides the ordinary print mode, the printer has the following modes to check the settings of the printer.

- Self-test Mode
- Hexadecimal Dumping Mode
- Auto Calibrate Label

4.1 Print a Parameter Setting Page (Self-test Page)

Before you connect the printer to the computer, make sure that the printer is in proper working order.

You can do this by printing a configuration status label.

1. Make sure the media is properly loaded, the top cover of the printer is closed and the printer is power off. Then, press and hold the Feed button once you are ready.
2. Hold down Feed Button and then switch on the printer until Power LED blinks once, buzzer beeps once.
3. The printer will print out a parameter setting page.

Here is the self-test status page and its explanation. The printout is an example. It may differ depending of installed options or interfaces:

Model	→	Model	DL-210
Serial Number	→	SN NO	XXXXXXXXXXXXXX
ID Number	→	ID NO	28.904.XX
F/W	→	Firmware version.....	40.XX.XX
Interface type	→	Interface.....	USB+Parallel
Serial setting	→	Serial interface.....	9600bps 8bitD/1bits/None
Emulation type	→	Emulation.....	ZPLII
		Media.....	Label
		Print Type.....	Direct Thermal
Media info and Printing method	→	Print Sensor.....	Reflect
		Print count.....	0m
		Label size.....	100.0mm
		Gap size.....	2.0mm
		Sensor AD.....	G3 D_300 B_0 1.09V 0.28V
Current memory size	→	Memory.....	8192K
Density	→	Print Density.....	2
Peeler status	→	Peeler.....	Off
Black mark status	→	Black Mark.....	Off
		Cutter.....	On
Cutter status	→	Cut mode.....	full cut
		Home position adjust.....	0 mm
Detect lack of media	→	Tear position adjust.....	0 mm
Auto verify label status	→	Paper end detection.....	On
Detect position status	→	Auto Calibrate Label.....	Off
Page mode status	→	Print Position Detection.....	Off
Current printing speed	→	Page mode.....	On
Current printing width	→	Print Speed.....	150mm/s
		Print Width.....	108mm (8dot.mm)

Complete

Tally Dascom

4.2 Hexadecimal Dumping Mode

Hold down Feed Button and switch on printer until Power LED blinks three times, buzzer beeps three times.

When the self-test is OK but on-line printing error occurs, you can check the communication between PC and program via Hexadecimal Dump mode. In Hexadecimal Dump mode, the printer will print out hexadecimal data once it receives the signal from host. With this information you can ask technical service for analysis.

The printer starts printing "HEX DUMP PRINT MODE" followed by the received data printed in hexadecimal numbers and some characters.

CAUTION!



- The printer prints "." if there is no characters corresponding to data.
 - During hexadecimal dump, functions except some command will be disabled.
 - If print data does not cover a line, press the FEED switch to print the line.
-

Printing example:

0123456789abcdefghijklmnopqrstuvwxyABCDEFGHIJKLMNOPQRSTUVWXYZ

```
Hexadecimal Dump
To terminate hexadecimal dump,
press FEED button.

30 31 32 33 34 35 36 37 38 39 61 62 63 64 65 66:0123456789abcdef
67 68 69 6A 6B 6C 6D 6E 6F 70 71 72 73 74 75 76:ghijklmnopqrstuv
77 78 79 7A 41 42 43 44 45 46 47 48 49 4A 4B 4C:xyzABCDEFGHIJKL

4D 4E 4F 50 51 52 53 54 55 56 57 58 59 5A      :MNOPQRSTUVWXYZ

*** Completed ***
```

Press the FEED button one time to feed the last line after the printer stops printing so as to return to the normal mode.

4.3 Auto Calibrate Label

DL-210 can calibrate label automatically. Hold down Feed Button and switch on printer till Power LED blinks twice, buzzer beeps twice.

Label calibration should be executed in the following situations:



- Use printer for printing label for the first time.
 - After replacing different size of labels.
 - If the printer skips labels
 - If the printer feeds blank labels.
 - After refilling with new roll of labels.
-

CHAPTER 5 TROUBLESHOOTING AND MAINTENANCE

Your printer is extremely reliable, but occasionally problems may occur. This chapter provides information on some of the common problems you may encounter and how you may solve them. If you encounter problems that you cannot resolve, please contact your dealer for assistance.

Read the following instructions before maintenance and avoid incorrect operation, so as to prevent injury to you and damage to the printer.

5.1 Common Issues

- **LED Indication and Buzzer Alarm**

Condition	Possible Cause	What to do?
No LEDs on	Power cord unplugged	Check power cord and plug it properly
	Printer turned off	Turn on printer
	Damaged PCB	Contact service representatives
	Power source unavailable	Check the cable and adapter, or change another cable or/and adapter.
Status LED always on	Media ended	Re-load media
Error LED always on	Print head mechanism open	Close the print head mechanism
Status LED blinks	Label remaining in peeler	Remove label
	Ribbon ended	Replace ribbon
Error LED blinks and buzzer alarms	Thermal print head overheated	Turn the printer off and wait some minutes before resume
	Over-voltage	Print with specified voltage adapter
	Low-voltage	Print with specified voltage adapter
Power LED and Error LED fast blink three times, buzzer alarms three times	Gap sensor error alarm. The black mark sensor does not align with the receiving sensor, that it, two triangles do not align.	Move around the black mark sensor, so that the triangle aligns with another on the center housing.
Press feed button after power on, Error LED slowly blinks once and then fast blinks three times; buzzer alarms four times	Cutter error alarm. The cutter option is enabled, but the cutter is not installed.	Disable the cutter in the setup tool.
Error LED blinks fast	Gap detection error.	1. When using labels, remember to set the proper media with the setup tool.
		2. Due to sensor error or other problems, the sensor could not detect the gap. Clean or/and adjust the media sensor.

- **Printing Error**

Condition	Possible Cause	What to do?
Blurred or spot printing	Incorrect media roll installation	Check media roll and re-load it properly
	Media is out of specification	Use recommended media
	Dirty thermal print head or platen	Clean print head or platen
	Ribbon is out of specification	Use recommended ribbon
	Low print density	Increase the print density (use the setup tool instead)
	Print with Ribbon on Direct Thermal paper	Remove ribbon
Self-test fail	Hardware problem	Contact service representatives
Media jam	Label stuck	Check media path and clean jammed label, refer to Chapter 5 Section 5.3
Printer skips labels	Label positioning problem or label size setting exceeds the physical size.	Execute label calibration (refer to Chapter 4 section 4.3). If that doesn't work, you have to verify the label size setting is correct or not.
Printer feeds blank labels	Print without ribbon on transfer thermal paper	Install ribbon
Paper size setting correct but the printout is crooked, skewed, or off-center.	Label did not calibrate correctly	Execute label calibration (refer to Chapter 4 section 4.3).

5.2 Resetting the Factory Default Values

Sometimes, resetting the printer to the factory defaults may solve some problems.

There are two methods to set to factory setting:

Method one: Hold down Feed Button and switch on printer till Power LED blinks four times, buzzer beeps four times.

Method two: through setup tool, choose restore all setting on printer setup page.

5.3 Removing Jammed Label



After printing, the print head becomes very hot. Be careful not to touch it and to let it cool before you clean it

- (1) Turn printer off, open top cover and turn up print head mechanism.
- (2) Remove the jammed label and ribbon, clean the print head with a cotton swab with alcohol to remove any label glue remainings that could cause poor print quality.

(3) Reload media.

(4) Reload ribbon and turn the ribbon adjuster for rewinding the sticky part.

5.4 Cleaning Thermal Print Head



-
- After printing, the print head becomes very hot. Be careful not to touch it and to let it cool before you clean it.
 - Touching the print head with your fingers or a hard tool may damage it.
-
- Turn off the printer, open the top cover and remove ribbon, clean the thermal elements of the print head with a cotton swab moistened with alcohol solvent (ethanol, methanol, or isopropyl). Be gentle with the cleaning to avoid damaging the delicate printhead.
 - We recommend cleaning the thermal print head periodically (generally every 3 months) to maintain print quality.

5.5 Maintenance

DL-210 is designed for a long and reliable lifetime. But periodic maintenance is recommended in order to assure error free working. This also would guarantee the good print quality over the life time. It is recommended to clean the printer once every six months or after 300 hours duty.

Before cleaning, switch off the printer, wait a few seconds and unplug the power cord.

- Open the cover and remove the dust, paper shreds and other debris from inside by using a soft vacuum cleaner or a brush.
- In order to remove the dirt, you can wipe clean the machine with a soft cloth dipped in alcohol instead of the ketone or TEC solvent which may cause damage to the plastic parts. Please be aware that excessive moisture will lead to the improper functioning of electronic parts.
- Clean the platen roller with soft cloth.

While you are cleaning the printer, in order to avoid short circuit, do not damage or loose the cable or electronic parts, do not drop metal material inside, such as Paper Clips or Pins.

CHAPTER 6 COMMUNICATION INTERFACES SPECIFICATIONS

6.1 USB Interface

- **USB interface pin assignment**

PIN No.	Description	Classic wire color
1	VBUS	Red
2	D-	White
3	D+	Green
4	GND	Black

- **USB interface connector diagram**

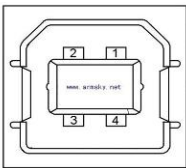

6.2 Wi-Fi Interface

Wi-Fi interface supports 2.4 GHz, IEEE Std. 802.11b/g standard.

6.3 Bluetooth Interface

Bluetooth version: Standard BT3.0/ 4.0+EDR

Communication protocol: SPP

Radio frequency: 2.4GHz

Transmission distance: 10m

6.4 Ethernet Interface

- **Ethernet interface pin assignment**

Pin. No.	Name	Description
1	TX+	Tranceive Data+
2	TX-	Tranceive Data-
3	RX+	Receive Data+
4	n/c	Not connected
5	n/c	Not connected
6	RX-	Receive Data-
7	n/c	Not connected
8	n/c	Not connected

- **Ethernet interface connector diagram**

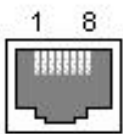

6.5 Serial Interface

- **Serial interface pin assignment**

Serial interface compatible with RS-232 standard, with 25 pin (D hole type) socket.

PIN No.	Description
PIN 1	Frame Ground
PIN 2	TXD
PIN 3	RXD
PIN 4	RTS
PIN 5	Unconnected
PIN 6	DSR
PIN 7	Signal Ground
PIN 8~19	Unconnected
PIN 20	DTR
PIN 21~25	Unconnected

User can view the setting of interface via printing configuration sample.

The default setting of serial interface is as follow, 38400 bps (baud rates), 8 bit (data bit), 1 bit (stop bit), no parity, support RTS/CTS handshaking protocol.

- **Serial interface connector diagram**

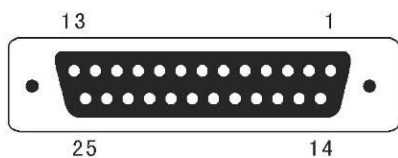

6.6 Parallel Interface

- **Parallel interface pin assignment**

Parallel interface with 36 pin CENTRONICS socket.

Pin No.	Signal From	Description
1	H	Strobe Signal; Data latch pulse, latch the data to the printer at the rising edge of the negative pulse.
2	H	Data 0 (The lowest bit)
3	H	Data 1
4	H	Data 2
5	H	Data 3
6	H	Data 4
7	H	Data 5
8	H	Data 6
9	H	Data 7 (The highest bit)
10	P	ACK Signal; Printer response signal, indicates that the printer has received a Data byte.
11	P	Busy Signal; The printer is busy; High level indicates that the printer can't receive data.
12	P	PE Signal; Paper end signal; High level indicates that the printer is out of paper.
13	—	Unconnected
14	—	Unconnected
15	—	Unconnected
16	Logic Ground	
17	Frame Ground, separated from logic ground.	
18	—	5V/500mA power output
19~30	Logic Ground	
31	—	Initialization signal
32	P	Printer error signal. Low level indicates that an error occurs in the printer. It will come with paper end.
33	Logic Ground	
34~35	—	Unconnected
36	Unconnected	

Remarks:

H indicates that signal comes from Host computer; P indicates that signal comes from Printer.

- **Parallel interface connector diagram**

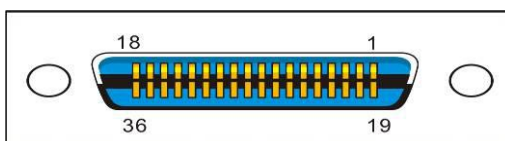

6.7 Power Supply

(1) Power adapter

Input: AC 100V-240V~ 1.5A 50-60Hz

Output: DC 24V \pm 5%, 2.1A, A-1009-3P interface

(2) Power Supply connector diagram

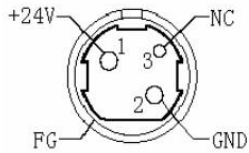

(3) Power Socket pin assignment

Pin Number	Signal Name
1	+24 V
2	GND
3	N.C
SHELL	F.G.

(4) Power Supply interface type

Printer - Unetop DC-002 or similar products

Computer - Unetop DP-002 or similar products

CHAPTER 7 CHARACTER CODE PAGES



- The character code tables show only character configurations. They do not show the actual print pattern.
- “SP” in the table shows a space.

7.1 Common to All Pages (International Character Set: Usa)

HEX	0	1	2	3	4	5	6	7
0	NUL 00	DLE 16	SP 32	0 48	@ 64	P 80	` 96	p 112
1		XON 17	! 33	1 49	A 65	Q 81	a 97	q 113
2			“ 34	2 50	B 66	R 82	b 98	R 114
3		XOFF 19	# 35	3 51	C 67	S 83	c 99	s 115
4	EOT 04	DC4 20	\$ 36	4 52	D 68	T 84	d 100	t 116
5	ENQ 05	NAK 21	% 37	5 53	E 69	U 85	e 101	u 117
6	ACK 06		& 38	6 54	F 70	V 86	f 102	V 118
7		CAN 23	‘ 39	7 55	G 71	W 87	g 103	w 119
8			(40	8 56	H 72	X 88	h 104	x 120
9	HT 09) 41	9 57	I 73	Y 89	i 105	y 121
A	LF 10		* 42	: 58	J 74	Z 90	j 106	Z 122
B		ESC 27	+ 43	; 59	K 75	[91	k 107	{ 123
C	FF 12	FS 28	, 44	< 60	L 76	\ 92	l 108	 124
D	CR 13	GS 29	- 45	= 61	M 77] 93	m 109	} 125
E		RS 30	. 46	> 62	N 78	^ 94	n 110	~ 126
F			/ 47	? 63	O 79	_ 95	o 111	SP 127

7.2 International Character Sets

Country	ASCII code (Hex)											
	23	24	40	5B	5C	5D	5E	60	7B	7C	7D	7E
USA	#	\$	@	[\]	^	`	{		}	~
France	#	\$	à	°	ç	§	^	`	é	ù	è	¨
Germany	#	\$	§	Ä	Ö	Ü	^	`	ä	ö	ü	ß
U.K.	£	\$	@	[\]	^	`	{		}	~
Denmark I	#	\$	@	Æ	Ø	Å	^	`	æ	ø	å	~
Sweden	#	¤	É	Ä	Ö	Å	Ü	é	ä	ö	å	ü
Italy	#	\$	@	°	\	é	^	ù	à	ò	è	ì
Spain I	Pt	\$	@	ı	Ñ	ı	^	`	¨	ñ	}	~
Japan	#	\$	@	[¥]	^	`	{		}	~
Norway	#	¤	É	Æ	Ø	Å	Ü	é	æ	ø	å	ü
Denmark II	#	\$	É	Æ	Ø	Å	Ü	é	æ	ø	å	ü
Spain II	#	\$	á	ı	Ñ	ı	é	`	ı	ñ	ó	ú
Latin America	#	\$	á	ı	Ñ	ı	é	ü	ı	ñ	ó	ú
Korea	#	\$	@	[W]	^	`	{		}	~
Slovenia/ Croatia	#	\$	Ž	Š	Đ	Ć	Č	ž	š	đ	ć	č
China	#	¥	@	[\]	^	`	{		}	~

7.3 [User-Defined Page]

HEX	8	9	A	B	C	D	E	F
0	SP 128	SP 144	SP 160	SP 176	SP 192	SP 208	SP 224	SP 240
1	SP 129	SP 145	SP 161	SP 177	SP 193	SP 209	SP 225	SP 241
2	SP 130	SP 146	SP 162	SP 178	SP 194	SP 210	SP 226	SP 242
3	SP 131	SP 147	SP 163	SP 179	SP 195	SP 211	SP 227	SP 243
4	SP 132	SP 148	SP 164	SP 180	SP 196	SP 212	SP 228	SP 244
5	SP 133	SP 149	SP 165	SP 181	SP 197	SP 213	SP 229	SP 245
6	SP 134	SP 150	SP 166	SP 182	SP 198	SP 214	SP 230	SP 246
7	SP 135	SP 151	SP 167	SP 183	SP 199	SP 215	SP 231	SP 247
8	SP 136	SP 152	SP 168	SP 184	SP 200	SP 216	SP 232	SP 248
9	SP 137	SP 153	SP 169	SP 185	SP 201	SP 217	SP 233	SP 249
A	SP 138	SP 154	SP 170	SP 186	SP 202	SP 218	SP 234	SP 250
B	SP 139	SP 155	SP 171	SP 187	SP 203	SP 219	SP 235	SP 251
C	SP 140	SP 156	SP 172	SP 188	SP 204	SP 220	SP 236	SP 252
D	SP 141	SP 157	SP 173	SP 189	SP 205	SP 221	SP 237	SP 253
E	SP 142	SP 158	SP 174	SP 190	SP 206	SP 222	SP 238	SP 254
F	SP 143	SP 159	SP 175	SP 191	SP 207	SP 223	SP 239	SP 255

7.4 [PC437: USA, Standard Europe]

HEX	8	9	A	B	C	D	E	F
0	Ç 128	É 144	á 160	☐ 176	Ł 192	Ⓔ 208	α 224	≡ 240
1	ü 129	æ 145	í 161	☐ 177	⊥ 193	⸍ 209	β 225	± 241
2	é 130	Æ 146	ó 162	☐ 178	⸗ 194	⸎ 210	Γ 226	≥ 242
3	â 131	ô 147	ú 163	 179	⸗ 195	Ⓔ 211	π 227	≤ 243
4	ä 132	ö 148	ñ 164	⸗ 180	— 196	⸗ 212	Σ 228	 244
5	à 133	ò 149	Ñ 165	⸗ 181	⸗ 197	ƒ 213	σ 229	∫ 245
6	å 134	û 150	ä 166	⸗ 182	ƒ 198	π 214	μ 230	÷ 246
7	ç 135	ù 151	œ 167	π 183	⸗ 199	⸗ 215	τ 231	≈ 247
8	ê 136	ÿ 152	¿ 168	⸗ 184	Ⓔ 200	⸗ 216	Φ 232	° 248
9	ë 137	Ö 153	Г 169	⸗ 185	⸗ 201	⸗ 217	Θ 233	• 249
A	è 138	Ü 154	Г 170	⸗ 186	Ⓔ 202	Г 218	Ω 234	· 250
B	ï 139	ø 155	½ 171	⸗ 187	⸗ 203	■ 219	δ 235	√ 251
C	î 140	£ 156	¼ 172	⸗ 188	⸗ 204	■ 220	∞ 236	n 252
D	ì 141	¥ 157	ì 173	⸗ 189	= 205	■ 221	Φ 237	² 253
E	Ä 142	Pt 158	« 174	⸗ 190	⸗ 206	■ 222	ε 238	■ 254
F	Å 143	f 159	» 175	Г 191	⸗ 207	■ 223	∩ 239	SP 255

7.5 [PC850: Multilingual]

HEX	8	9	A	B	C	D	E	F
0	Ç 128	É 144	á 160	☐ 176	Ł 192	ö 208	Ó 224	- 240
1	ü 129	æ 145	í 161	☐ 177	Ł 193	Đ 209	β 225	± 241
2	é 130	Æ 146	ó 162	☐ 178	Т 194	Ê 210	Ô 226	= 242
3	â 131	ô 147	ú 163	 179	† 195	Ë 211	Ò 227	¾ 243
4	ä 132	ö 148	ñ 164	† 180	- 196	È 212	ö 228	¶ 244
5	à 133	ò 149	Ñ 165	Á 181	† 197	ı 213	Õ 229	§ 245
6	å 134	û 150	ä 166	Â 182	ã 198	Í 214	μ 230	÷ 246
7	ç 135	ù 151	ó 167	À 183	Ã 199	Î 215	þ 231	˘ 247
8	ê 136	ÿ 152	ı 168	© 184	Ł 200	Ï 216	þ 232	° 248
9	ë 137	Ö 153	® 169	¶ 185	ƒ 201	Ɔ 217	Ú 233	˙ 249
A	è 138	Ü 154	¬ 170	 186	Ł 202	ƒ 218	Û 234	· 250
B	ï 139	ø 155	½ 171	¶ 187	ƒ 203	■ 219	Ü 235	¹ 251
C	î 140	£ 156	¼ 172	¶ 188	ƒ 204	■ 220	Ý 236	³ 252
D	ì 141	Ø 157	ı 173	¢ 189	= 205	ı 221	Ý 237	² 253
E	Ä 142	× 158	« 174	¥ 190	ƒ 206	Ï 222	- 238	■ 254
F	Å 143	f 159	» 175	ƒ 191	α 207	■ 223	' 239	SP 255

7.6 [PC852: Latin2]

HEX	8	9	A	B	C	D	E	F
0	Ç 128	É 144	á 160	▒ 176	Ł 192	đ 208	Ó 224	- 240
1	ü 129	Í 145	í 161	▒ 177	Ł 193	Đ 209	β 225	” 241
2	é 130	Í 146	ó 162	▒ 178	Ł 194	Đ 210	Ô 226	‘ 242
3	â 131	ô 147	ú 163	 179	Ł 195	Ě 211	Ń 227	˘ 243
4	ä 132	ö 148	Ą 164	Ł 180	- 196	ď 212	ń 228	˘ 244
5	û 133	Ĺ 149	ą 165	Á 181	Ł 197	Ň 213	ň 229	§ 245
6	ć 134	ĭ 150	Ż 166	Â 182	Ǻ 198	í 214	Š 230	÷ 246
7	ç 135	Ś 151	ż 167	Ě 183	ǻ 199	î 215	š 231	˙ 247
8	ł 136	ś 152	Ę 168	Ş 184	Ł 200	ě 216	Ŕ 232	° 248
9	ë 137	Ö 153	ę 169	Ł 185	Ł 201	Ĵ 217	Ú 233	¨ 249
A	Ő 138	Ü 154	SP 170	Ł 186	Ł 202	ŕ 218	ř 234	• 250
B	ő 139	Ť 155	ž 171	Ł 187	Ł 203	▀ 219	Ů 235	ů 251
C	î 140	ĥ 156	Č 172	Ł 188	Ł 204	▀ 220	ý 236	Ř 252
D	Ž 141	ł 157	ş 173	Ž 189	= 205	Ł 221	Ý 237	ř 253
E	Ä 142	× 158	« 174	ž 190	Ł 206	Ů 222	ť 238	▀ 254
F	Ć 143	č 159	» 175	Ł 191	α 207	▀ 223	’ 239	SP 255

7.7 [PC858: Euro]

HEX	8	9	A	B	C	D	E	F
0	Ç 128	É 144	á 160	☐ 176	Ł 192	ø 208	Ó 224	- 240
1	ü 129	æ 145	í 161	☐ 177	ł 193	Ð 209	β 225	± 241
2	é 130	Æ 146	ó 162	☐ 178	ṽ 194	Ê 210	Ô 226	= 242
3	â 131	ô 147	ú 163	 179	† 195	Ë 211	Ò 227	¾ 243
4	ä 132	ö 148	ñ 164	‡ 180	- 196	È 212	õ 228	¶ 244
5	à 133	ò 149	Ñ 165	Á 181	‡ 197	€ 213	Õ 229	§ 245
6	å 134	û 150	ä 166	Â 182	ã 198	Í 214	μ 230	÷ 246
7	ç 135	ù 151	ó 167	À 183	Ã 199	Î 215	þ 231	˘ 247
8	ê 136	ÿ 152	ç 168	© 184	ℓ 200	Ï 216	ƒ 232	° 248
9	ë 137	Ö 153	® 169	¶ 185	℥ 201	Ɔ 217	Ú 233	¨ 249
A	è 138	Ü 154	¬ 170	 186	℥ 202	Ɔ 218	Û 234	· 250
B	ï 139	ø 155	½ 171	¶ 187	℥ 203	■ 219	Ü 235	¹ 251
C	î 140	£ 156	¼ 172	¶ 188	℥ 204	■ 220	Ý 236	³ 252
D	ì 141	Ø 157	í 173	¢ 189	= 205	¡ 221	Ý 237	² 253
E	Ä 142	× 158	« 174	¥ 190	¶ 206	Ï 222	- 238	■ 254
F	Å 143	f 159	» 175	‡ 191	α 207	■ 223	' 239	SP 255

7.8 [PC860: Portuguese]

HEX	8	9	A	B	C	D	E	F
0	Ç 128	É 144	á 160	☐ 176	Ł 192	⌌ 208	α 224	≡ 240
1	ü 129	À 145	í 161	☐ 177	⊥ 193	⌌ 209	β 225	± 241
2	é 130	È 146	ó 162	☐ 178	⊤ 194	⌌ 210	Γ 226	≥ 242
3	â 131	ô 147	ú 163	 179	⊥ 195	⌌ 211	π 227	≤ 243
4	ã 132	õ 148	ñ 164	⊥ 180	— 196	⌌ 212	Σ 228	 244
5	à 133	ò 149	Ñ 165	⊥ 181	⊥ 197	⌌ 213	σ 229	 245
6	Á 134	Ú 150	ä 166	⌌ 182	⌌ 198	⌌ 214	μ 230	÷ 246
7	ç 135	ù 151	ö 167	⌌ 183	⌌ 199	⌌ 215	τ 231	≈ 247
8	ê 136	Ï 152	ç 168	⊥ 184	⌌ 200	⊥ 216	Φ 232	° 248
9	Ê 137	Ö 153	Ò 169	⌌ 185	⌌ 201	⌌ 217	Θ 233	• 249
A	è 138	Ü 154	⊥ 170	⌌ 186	⌌ 202	⌌ 218	Ω 234	· 250
B	Í 139	φ 155	½ 171	⌌ 187	⌌ 203	■ 219	δ 235	√ 251
C	Ô 140	£ 156	¼ 172	⌌ 188	⌌ 204	■ 220	∞ 236	n 252
D	ì 141	Ù 157	ì 173	⌌ 189	= 205	■ 221	Φ 237	² 253
E	Ã 142	Pt 158	« 174	⊥ 190	⌌ 206	■ 222	ε 238	■ 254
F	Ä 143	Ó 159	» 175	⊥ 191	⌌ 207	■ 223	∩ 239	SP 255

7.9 [PC863: Canadian-French]

HEX	8	9	A	B	C	D	E	F
0	Ç 128	É 144	Ì 160	⋮ 176	Ł 192	⋮ 208	α 224	≡ 240
1	Û 129	È 145	´ 161	⋮ 177	⊥ 193	⌘ 209	β 225	± 241
2	é 130	Ê 146	ó 162	⋮ 178	⊤ 194	⌘ 210	Γ 226	≥ 242
3	â 131	ô 147	ú 163	 179	ƒ 195	⋮ 211	⌘ 227	≤ 243
4	Â 132	Ë 148	¨ 164	‡ 180	— 196	⋮ 212	Σ 228	 244
5	à 133	Ï 149	˙ 165	‡ 181	† 197	ƒ 213	σ 229	 245
6	¶ 134	û 150	³ 166	‡ 182	ƒ 198	⌘ 214	μ 230	÷ 246
7	ç 135	ù 151	— 167	⌘ 183	‡ 199	‡ 215	τ 231	≈ 247
8	ê 136	α 152	Î 168	‡ 184	⋮ 200	≠ 216	Φ 232	° 248
9	ë 137	Ô 153	ƒ 169	‡ 185	ƒ 201	⌘ 217	Θ 233	• 249
A	è 138	Ü 154	¬ 170	‡ 186	⋮ 202	ƒ 218	Ω 234	· 250
B	ï 139	ϕ 155	½ 171	‡ 187	⌘ 203	■ 219	δ 235	√ 251
C	î 140	£ 156	¼ 172	‡ 188	‡ 204	■ 220	∞ 236	n 252
D	= 141	Ù 157	¾ 173	⋮ 189	= 205	■ 221	Φ 237	² 253
E	À 142	Û 158	« 174	‡ 190	‡ 206	■ 222	ε 238	■ 254
F	§ 143	f 159	» 175	‡ 191	⋮ 207	■ 223	∩ 239	SP 255

7.10 [PC865: Nordic]

HEX	8	9	A	B	C	D	E	F
0	Ç 128	É 144	á 160	☐ 176	Ł 192	Ɑ 208	α 224	≡ 240
1	ü 129	æ 145	í 161	☐ 177	⊥ 193	Ɱ 209	β 225	± 241
2	é 130	Æ 146	ó 162	☐ 178	⊤ 194	Ɐ 210	Γ 226	≥ 242
3	â 131	ô 147	ú 163	 179	⊥ 195	Ɒ 211	Π 227	≤ 243
4	ä 132	ö 148	ñ 164	⊥ 180	— 196	ⱱ 212	Σ 228	∫ 244
5	à 133	ò 149	Ñ 165	⊥ 181	⊕ 197	Ⱳ 213	σ 229	∫ 245
6	å 134	û 150	ä 166	⊥ 182	ⱳ 198	ⱳ 214	μ 230	÷ 246
7	ç 135	ù 151	ø 167	ⱴ 183	ⱴ 199	ⱴ 215	τ 231	≈ 247
8	ê 136	ÿ 152	č 168	Ⱶ 184	Ⱶ 200	Ⱶ 216	Φ 232	° 248
9	ë 137	Ö 153	ŗ 169	ⱶ 185	ⱶ 201	ⱶ 217	Θ 233	• 249
A	è 138	Ü 154	ŕ 170	ⱷ 186	ⱷ 202	ⱷ 218	Ω 234	· 250
B	ï 139	ø 155	½ 171	ⱸ 187	ⱸ 203	■ 219	δ 235	√ 251
C	î 140	£ 156	¼ 172	ⱹ 188	ⱹ 204	■ 220	∞ 236	n 252
D	ì 141	Ø 157	ì 173	ⱺ 189	= 205	■ 221	Φ 237	² 253
E	Ä 142	Pt 158	« 174	ⱻ 190	ⱻ 206	■ 222	ε 238	■ 254
F	Å 143	f 159	α 175	ⱼ 191	ⱼ 207	■ 223	∩ 239	SP 255

7.11 [PC866: Cyrillic #2]

HEX	8	9	A	B	C	D	E	F
0	А 128	Р 144	а 160	▒ 176	Л 192	л 208	р 224	Ё 240
1	Б 129	С 145	б 161	▒ 177	┘ 193	т 209	с 225	ё 241
2	В 130	Т 146	в 162	▒ 178	т 194	т 210	т 226	Є 242
3	Г 131	У 147	г 163	 179	┘ 195	л 211	у 227	є 243
4	Д 132	Ф 148	д 164	┘ 180	— 196	ѣ 212	ф 228	ї 244
5	Е 133	Х 149	е 165	┘ 181	┘ 197	ѣ 213	х 229	і 245
6	Ж 134	Ц 150	ж 166	 182	ѣ 198	г 214	ц 230	ÿ 246
7	З 135	Ч 151	з 167	т 183	 199	 215	т 231	ÿ 247
8	И 136	Ш 152	и 168	ѣ 184	л 200	ѣ 216	ш 232	° 248
9	Й 137	Щ 153	й 169	 185	г 201	л 217	щ 233	• 249
A	К 138	Ъ 154	к 170	 186	л 202	г 218	ъ 234	· 250
B	Л 139	Ы 155	л 171	т 187	т 203	▀ 219	ы 235	√ 251
C	М 140	Ь 156	м 172	л 188	л 204	▀ 220	ь 236	№ 252
D	Н 141	Э 157	н 173	л 189	= 205	▀ 221	э 237	¤ 253
E	О 142	Ю 158	о 174	л 190	л 206	▀ 222	ю 238	■ 254
F	П 143	Я 159	п 175	┘ 191	л 207	▀ 223	я 239	SP 255

7.12 [PC720: Arabic]

HEX	8	9	A	B	C	D	E	F
0	SP 128	SP 144	ب 160	ٲ 176	ل 192	ل 208	ض 224	ٲ 240
1	SP 129	ء 145	ة 161	ٲ 177	ل 193	ٲ 209	ط 225	ٲ 241
2	é 130	° 146	ت 162	ٲ 178	ٲ 194	ٲ 210	ظ 226	ٲ 242
3	a 131	ô 147	ث 163	ل 179	ٲ 195	ل 211	ع 227	ٲ 243
4	SP 132	ؠ 148	ج 164	ٲ 180	ـ 196	ٲ 212	غ 228	ٲ 244
5	à 133	- 149	ح 165	ٲ 181	ٲ 197	ٲ 213	ف 229	ٲ 245
6	SP 134	ù 150	خ 166	ٲ 182	ٲ 198	ٲ 214	ٲ 230	ٲ 246
7	ç 135	ù 151	د 167	ٲ 183	ٲ 199	ٲ 215	ق 231	≈ 247
8	ê 136	ء 152	ذ 168	ٲ 184	ل 200	ٲ 216	ك 232	° 248
9	ë 137	أ 153	ر 169	ٲ 185	ٲ 201	ل 217	ل 233	° 249
A	è 138	أ 154	ز 170	ٲ 186	ل 202	ٲ 218	م 234	° 250
B	ï 139	ؤ 155	س 171	ٲ 187	ٲ 203	■ 219	ن 235	√ 251
C	î 140	£ 156	ش 172	ك 188	ٲ 204	■ 220	ه 236	° 252
D	SP 141	! 157	ص 173	ل 189	ٲ 205	■ 221	و 237	2 253
E	SP 142	ى 158	« 174	ل 190	ل 206	■ 222	ى 238	■ 254
F	SP 143	ا 159	» 175	ل 191	SP 207	■ 223	ي 239	SP 255

CHAPTER 8 COMMAND SETS

8.1 ZPL Command Sets

Commands	Function
^A	Scalable/Bitmapped Font
^A@	Use Font Name to Call Font
^B0	Aztec Bar Code Parameters
^B1	Code 11 Bar Code
^B2	Interleaved 2 of 5 Bar Code
^B3	Code 39 Bar Code
^B4	Code 49 Bar Code
^B5	Planet Code bar code
^B7	PDF417 Bar Code
^B8	EAN-8 Bar Code
^B9	UPC-E Bar Code
^BA	Code 93 Bar Code
^BB	CODABLOCK Bar Code
^BC	Code 128 Bar Code (Subsets A, B, and C)
^BD	UPS MaxiCode Bar Code
^BE	EAN-13 Bar Code
^BF	MicroPDF417 Bar Code
^BI	Industrial 2 of 5 Bar Codes
^BJ	Standard 2 of 5 Bar Code
^BK	ANSI Codabar Bar Code
^BL	LOGMARS Bar Code
^BM	MSI Bar Code
^BO	Aztec Bar Code Parameters
^BP	Plessey Bar Code
^BQ	QR Code Bar Code
^BR	GS1 Databar (formerly Reduced Space Symbology)
^BS	UPC/EAN Extensions
^BT	TLC39 Bar Code
^BU	UPC-A Bar Code
^BX	Data Matrix Bar Code
^BY	Bar Code Field Default

Commands	Function
^CC ~CC	Change Caret
^BZ	POSTAL Bar Code
^CD	~CD Change Delimiter
^CF	Change Alphanumeric Default Font
^CI	Change International Font/Encoding
^CM	Change Memory Letter Designation
^CO	Cache On
^CP	Remove Label
^CV	Code Validation
^CW	Font Identifier
~DB	Download Bitmap Font
~DE	Download Encoding
^DF	Download Format
~DG	Download Graphics
~DN	Abort Download Graphic
~DS	Download Intellifont (Scalable Font)
~DT	Download Bounded TrueType Font
~DU	Download Unbounded TrueType Font
~DY	Download Objects
~EG	Erase Download Graphics
^FB	Field Block
^FC	Field Clock
^FD	Field Data
^FH	Field Hexadecimal Indicator
^FL	Font Linking
^FM	Multiple Field Origin Locations
^FN	Field Number
^FO	Field Origin
^FP	Field Parameter
^FR	Field Reverse Print
^FS	Field Separator
^FT	Field Typeset
^FV	Field Variable
^FW	Field Orientation

Commands	Function
^FX	Comment
^GB	Graphic Box
^GC	Graphic Circle
^GD	Graphic Diagonal Line
^GE	Graphic Ellipse
^GF	Graphic Field
^GS	Graphic Symbol
~HB	Battery Status
~HD	Head Diagnostic
^HF	Host Format
^HG	Host Graphic
^HH	Configuration Label Return
~HI	Host Identification
~HM	Host RAM Status
~HQ	Host Query
~HQ	Examples
~HS	Host Status Return
^HT	Host Linked Fonts List
~HU	Return ZebraNet Alert Configuration
^HV	Host Verification
^HW	Host Directory List
^HY	Upload Graphics
^HZ	Display Description Information
^ID	Object Delete
^IL	Image Load
^IM	Image Move
^IS	Image Save
~JA	Cancel All
^JB	Initialize Flash Memory
~JB	Reset Optional Memory
~JC	Set Media Sensor Calibration
~JD	Enable Communications Diagnostics
~JE	Disable Diagnostics
~JF	Set Battery Condition

Commands	Function
~JG	Graphing Sensor Calibration
^JH	Early Warning Settings
^JI	Start ZBI (Zebra BASIC Interpreter)
~JI	Start ZBI (Zebra BASIC Interpreter)
^JJ	Set Auxiliary Port
~JL	Set Label Length
^JM	Set Dots per Millimeter
~JN	Head Test Fatal
~JO	Head Test Non-Fatal
~JP	Pause and Cancel Format
~JQ	Terminate Zebra BASIC Interpreter
~JR	Power On Reset
^JS	Sensor Select
~JS	Change Backfeed Sequence
^JT	Head Test Interval
^JU	Configuration Update
^JW	Set Ribbon Tension
~JX	Cancel Current Partially Input Format
^JZ	Reprint After Error
~KB	Kill Battery (Battery Discharge Mode)
^KD	Select Date and Time Format (for Real Time Clock)
^KL	Define Language
^KN	Define Printer Name
^KV	Kiosk Values
^LF	List Font Links
^LH	Label Home
^LL	Label Length
^LR	Label Reverse Print
^LS	Label Shift
^LT	Label Top
^MA	Set Maintenance Alerts
^MC	Map Clear
^MD	Media Darkness
^MF	Media Feed

Commands	Function
^ML	Maximum Label Length
^MM	Print Mode
^MN	Media Tracking
^MP	Mode Protection
^MT	Media Type
^MU	Set Units of Measurement
^MW	Modify Head Cold Warning
^NC	Select the Primary Network Device
~NC	Network Connect
^ND	Change Network Settings
^NI	Network ID Number
~NR	Set All Network Printers Transparent
^NS	Change Wired Networking Settings
~NT	Set Currently Connected Printer Transparent
^PA	Advanced Text Properties
^PF	Slew Given Number of Dot Rows
^PH ~PH	Slew to Home Position
~PL	Present Length Addition
^PM	Printing Mirror Image of Label
^PN	Present Now
^PO	Print Orientation
^PP ~PP	Programmable Pause
^PQ	Print Quantity
^PR	Print Rate
~PR	Applicator Reprint
~PS	Print Start
^PW	Print Width
~RO	Reset Advanced Counters
^SC	Set Serial Communications
~SD	Set Darkness
^SE	Select Encoding Table
^SF	Serialization Field (with a Standard ^FD String)
^SI	Set Sensor Intensity
^SN	Serialization Data

Commands	Function
^SP	Start Print
^SQ	Halt ZebraNet Alert
^SR	Set Print head Resistance
^SS	Set Media Sensors
^SZ	Set ZPL
^TB	Text Blocks
^TO	Transfer Object
~WC	Print Configuration Label
^WD	Print Directory Label
~WQ	Write Query
~WQ	Examples
^XA	Start Format
^XB	Suppress Backfeed
^XF	Recall Format
^XG	Recall Graphic
^XS	Set Dynamic Media Calibration
^XZ	End Format
^ZZ	Printer Sleep

8.2 EPL Command Sets

Commands	Function
A	ASCII text
B	Bar Code (EAN-8 / EAN-13 / UPC-A / Interleaved 25 / Codabar / UPC-E / Code39 / Code 128)
b	MaxCode (Data Matrix / PDF417 / QR Code)
C	Cut Immediate
D	Density
EI	Print Soft Font Info.
EK	Delete Soft Font
ES	Store Soft Font
f	Cut/peel position
GG	Tetrieve Graphics
GI	Print Graphics Info.
GK	Delete Graphic
GM	Store Graphic
I	Character Set Selection
JF	Enable Top of Form Backup
LO	Line Draw Black
LS	Line Draw Diagonal
N	Clear Image Buffer
O	Options Select
P	Print
q	Set Label Width
Q	Set Form Width
R	Set Reference Point
S	Speed Select
X	Box Draw
Z	Print Direction
;	Code Anotation
^@	Reset Printer
^default	Set Printer to Factory Defaults

8.3 TSPL Command Sets

Commands	Function
SIZE	This command defines the label width and length
BLINE	This command sets the height of the black line and the user-defined extra label feeding length each form feed takes.
BARCODE	This command prints 1D barcodes
QRCODE	This command prints QR code.
GAP	Defines the gap distance between two labels.
REFERENCE	This command defines the reference point of the label
SPEED	This command defines the print speed
DENSITY	This command sets the printing darkness
SET PEEL	This setting is used to enable/disable the self-peeling function. The default setting for this function is off
SET CUTTER	This setting activates or deactivates the cutter and defines how many printed labels is to be cut at one time
SET PARTIAL_CUTTER	This setting activates or deactivates the cutter and defines how many printed labels is to be cut at one time
SET TEAR	This command is used to enable/disable feeding of labels to gap/black mark position for tearing off.
SET RIBBON	This setting is used to enable/disable ribbon sensor detection
DIRECTION	This command defines the printout direction
SHIFT	This command moves the label' s vertical position.
OFFSET	This command defines the selective, extra label feeding length each form feed takes, which, especially in peel-off mode and cutter mode, is used to adjust label stop position, so as for label to register at proper places for the intended purposes. The printer back tracks the extra feeding length before the next run of printing.
BITMAP	This command draws bitmap images
REVERSE	This command reverses a region in image buffer
CLS	This command clears the image buffer.
PRINT	This command prints the label format currently stored in the image buffer
PUTPCX	This command prints PCX format images
KILL	This command deletes a file in the printer memory
DOWNLOAD	“DOWNLOAD” is a header of the file that is to be saved in the printer' s memory

Appendix I: AUTOCUTTER (OPTION)

Cutter is the factory option of the printer. It will be installed in the printer before shipment if configured.

Removing the Tear Bar

(1) Turn off the printer power and open the top cover and the print head mechanism, and then pull the tear bar to your side.

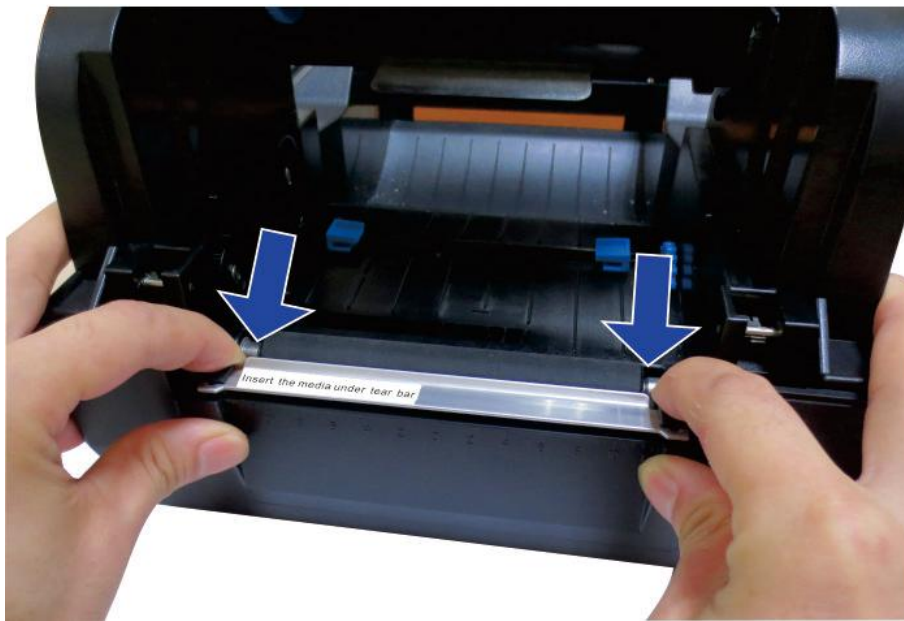

(2) Lift the tear bar up and it can be easily removed.

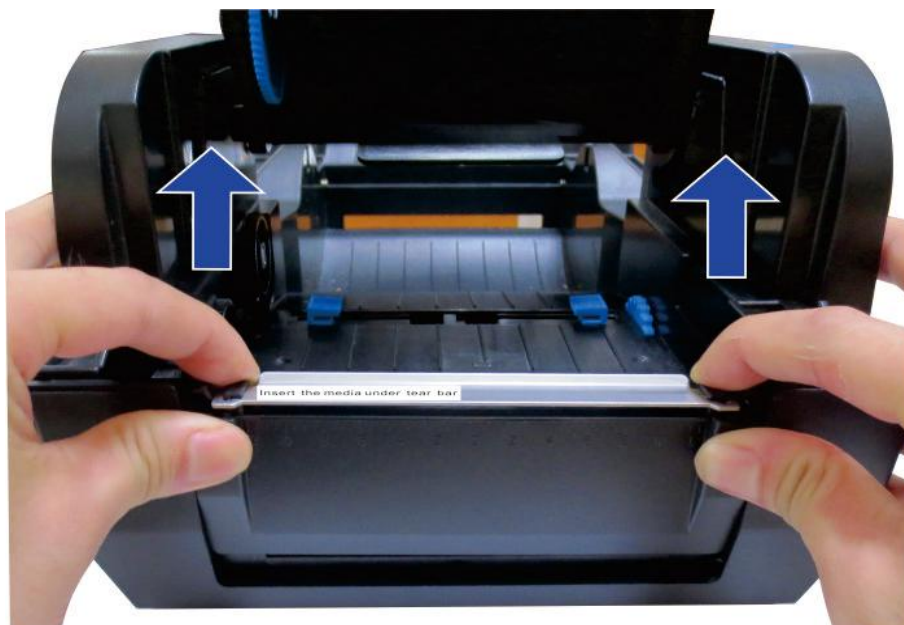

(3) The tear bar is removed.

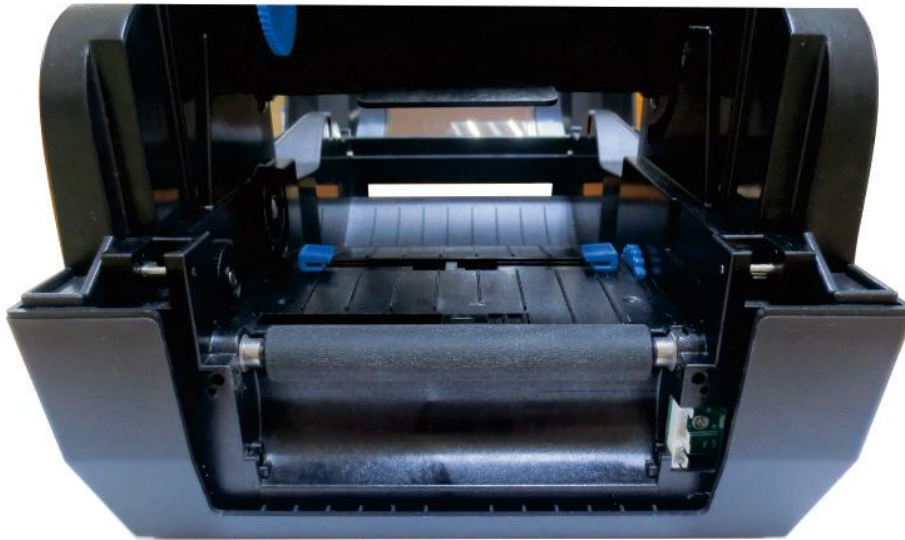

Note: Do it in reverse steps so as to install the tear bar.

Installing the Auto Cutter

- (1) Power down the printer before installing the cutter. Plug in the cutter connector to the printer.

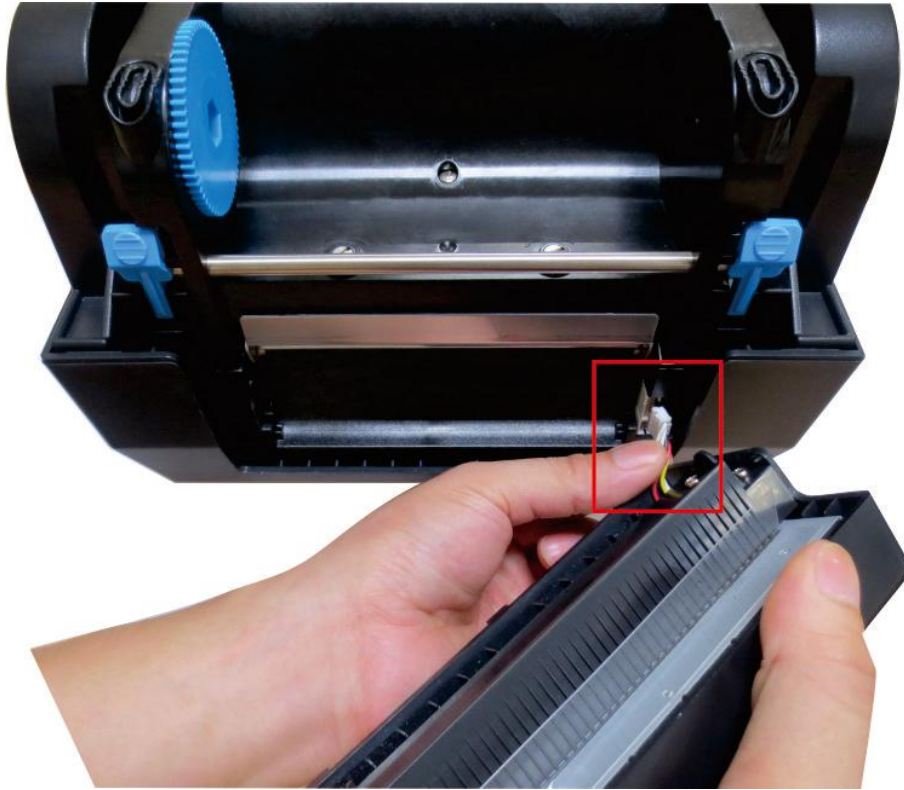

- (2) Put the auto cutter onto the slot of the low casing.

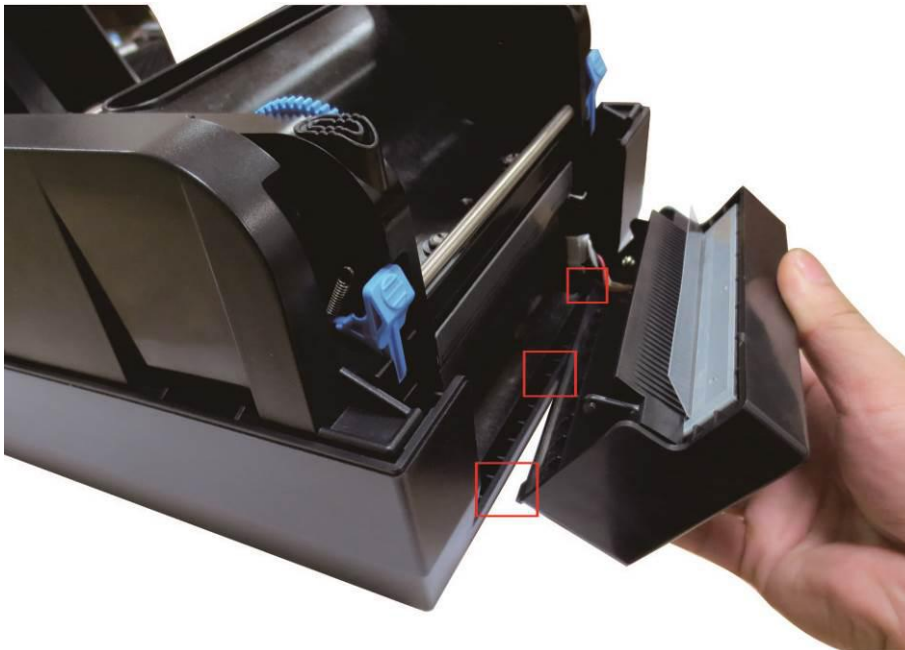

(3) Move the auto cutter gently to the reverse board till you hear the click sound.

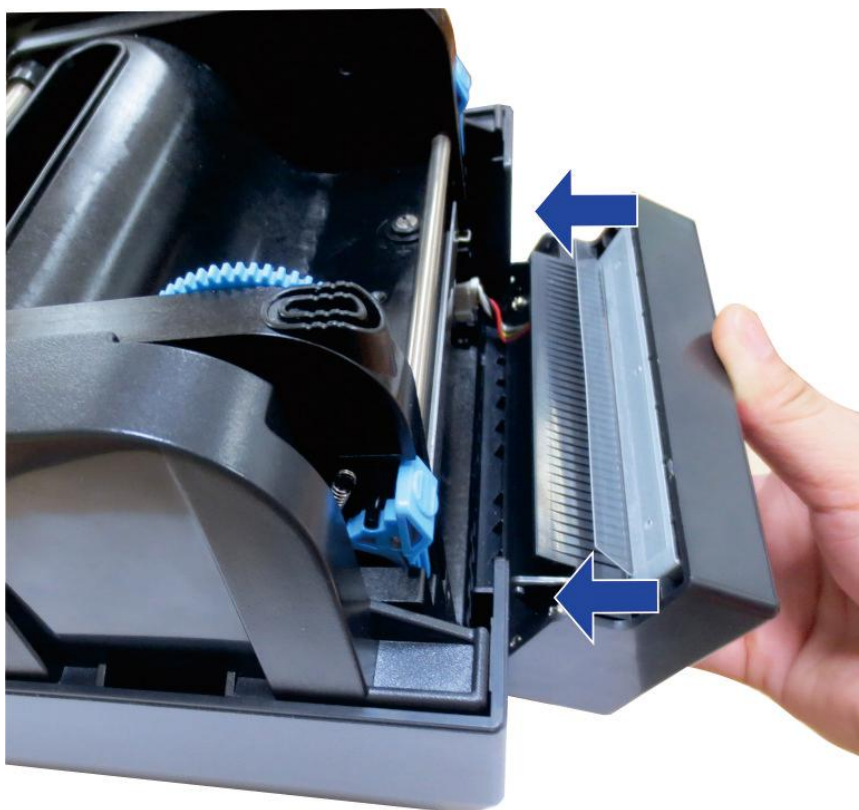

(4) Enable the cutter in the setup tool.

(5) After installation, you can use the auto cutter.



Appendix II: PEELER (OPTION)

Peeler is the factory option of the printer. It will be installed in the printer before shipment if configured.



Appendix III: FCC STATEMENT

1. This device complies with Part 15 of the FCC Rules. Operation is subject to the following two conditions:

- 1) This device may not cause harmful interference.
- 2) This device must accept any interference received, including interference that may cause undesired operation.

2. Changes or modifications not expressly approved by the party responsible for compliance could void the user's authority to operate the equipment.



This equipment has been tested and found to comply with the limits for a Class B digital device, pursuant to Part 15 of the FCC Rules. These limits are designed to provide reasonable protection against harmful interference in a residential installation.

This equipment generates uses and can radiate radio frequency energy and, if not installed and used in accordance with the instructions, may cause harmful interference to radio communications. However, there is no guarantee that interference will not occur in a particular installation. If this equipment does cause harmful interference to radio or television reception, which can be determined by turning the equipment off and on, the user is encouraged to try to correct the interference by one or more of the following measures:

- Re-orientate or relocate the receiving antenna.
- Increase the separation between the equipment and receiver.
- Connect the equipment into an outlet on a circuit different from that to which the receiver is connected.
- Consult the dealer or an experienced radio/TV technician for help.

DASCOM REPRESENTATIVES

GERMANY

DASCOM Europe GmbH
Heuweg 3
89079 Ulm
Germany
Tel.: +49 (0) 731 2075 0
Fax: +49 (0) 731 2075 100
www.dascom.com

UNITED KINGDOM

DASCOM GB Ltd
Hart House, Priestley Road,
Basingstoke, Hampshire
RG24 9PU, England
Phone: +44 (0) 1256 355130
Fax: +44 (0) 1256 481400
www.dascom.com

SINGAPORE (ASIA PACIFIC)

DASCOMAP Pte Ltd
2 Jurong East Street 21
05-42, IMM Building
Singapore 609601
Phone: +65 6760 8833
Fax: +65 6760 1066
www.dascom.com

AMERICAS

Dascom Americas Corporation
34 Lakeview Court
Verona, VA 24482
USA
Phone: +1 (877) 434 1377
Fax: +1 (877) 334 0549
www.dascom.com

FRANCE

DASCOM Europe GmbH
117 Avenue Victor Hugo
92100 Boulogne-Billancourt
France
Phone: +33 (1) 73 02 51 98
www.dascom.com

CHINA

JIANGMEN DASCOM COMPUTER
PERIPHERALS CO., LTD
No.399, jinxing Road,
Jianghai District Jiangmen,
P.R. China
www.dascom.com

“All rights reserved. Translations, reprinting or copying by any means of this manual complete or in part or in any different form requires our explicit approval. We reserve the right to make changes to this manual without notice. All care has been taken to ensure accuracy of information contained in this manual. However, we cannot accept responsibility for any errors or damages resulting from errors or inaccuracies of information herein.”