

DP-581 Series

Operator's Manual



www.dascom.com



This device fulfils the European standards requirements by complying with the Directive relating to electromagnetic compatibility and relating to low-voltage electrical equipment. Furthermore, it fulfils the requirements for RoHS and RED if applicable.

Conformity with the above-mentioned Directives is indicated by the CE symbol attached to the device.

Note: Conformity may be affected by:

- using interface cables not complying with the specifications
- non-observance of important instructions in the operator's manual
- installing components not approved for this device by the manufacturer
- unauthorized manipulation



Dieses Gerät erfüllt die Anforderungen der Europäischen Normen durch Einhaltung der Richtlinien bezüglich der Elektromagnetischen Verträglichkeit sowie bezüglich Elektrischer Betriebsmittel mit Niederspannung. Des Weiteren werden die Anforderungen bezüglich RoHS und falls anwendbar RED erfüllt.

Die Konformität zu den oben angeführten Richtlinien ist durch das am Gerät angebrachte CE-Zeichen gekennzeichnet.

Hinweis: Die Konformität kann beeinflusst werden durch:

- Benutzung von nicht spezifizierten Schnittstellen
- Nichtbeachtung wichtiger Hinweise der Bedienungsanleitung
- Ersetzen von Bauteilen, die nicht vom Hersteller für dieses Gerät freigegeben wurden
- Eingriffe durch Unbefugte



This device complies with the requirements of the United Kingdom (UK) legislation of Electrical Safety Regulations, Electromagnetic Compatibility Regulations, if applicable the Radio Regulations and the Restriction of the Hazardous Substances in Electrical and Electronic Equipment Regulations.

FCC Part 15 Class B

This device complies with Part 15 of the FCC Rules. Operation is subject to the following two conditions: (1) this device may not cause harmful interference, and (2) this device must accept any interference received, including interference that may cause undesired operation.

This equipment has been tested and found to comply with the limits for a Class B digital device, pursuant to Part 15 of the FCC rules. These limits are designed to provide reasonable protection against harmful interference in a residential installation. This equipment generates, uses, and can radiate radio frequency energy and, if not installed and used in accordance with the instructions, may cause harmful interference to radio communications. However, there is no guarantee that interference will not occur in a particular installation. If this equipment does cause harmful interference to radio or television reception, which can be determined by turning the equipment off and on, the user is encouraged to try to correct the interference by one or more of the following measures:

- Reorient or relocate the receiving antenna.
- Increase the separation between the equipment and the receiver.
- Connect the equipment into an outlet on a circuit different from that to which the receiver is connected.
- Consult the dealer or an experienced radio/TV technician for help.

This equipment complies with Canadian and FCC radiation exposure limits set forth for an uncontrolled environment. This equipment is in direct contact with the body of the user under normal operating conditions. This transmitter must not be co-located or operating in conjunction with any other antenna or transmitter.

Part 15.21 Caution: Changes or modifications not expressly approved by Dascom could void the user's authority to operate the equipment.

Canadian Department of Communications Radio Interference Statement

This device complies with Industry Canada license-exempt RSS standard(s). Operation is subject to the following two conditions: 1) this device may not cause interference; 2) this device must accept any interference, including interference that may cause undesired operation of the device. Under Industry Canada regulations, this radio transmitter may only operate using an antenna of a type and maximum (or lesser) gain approved for the transmitter by Industry Canada. To reduce potential radio interference to other users, the antenna type and its gain should be so chosen that the equivalent isotropically radiated power (e.i.r.p.) is not more than that necessary for successful communication. Maximum power output plus maximum antenna gain of the EUT is: 4.5W/m², Limit is 10W/m².

Le présent appareil est conforme aux CNR d'Industrie Canada applicables aux appareils radio exempts de licence. L'exploitation est autorisée aux deux conditions suivantes : (1) l'appareil ne doit pas produire de brouillage, et (2) l'utilisateur de l'appareil doit accepter tout brouillage radioélectrique subi, même si le brouillage est susceptible d'en compromettre le fonctionnement. Conformément à la réglementation d'Industrie Canada, le présent émetteur radio peut fonctionner avec une antenne d'un type et d'un gain maximal (ou inférieur) approuvé pour l'émetteur par Industrie Canada.

Dans le but de réduire les risques de brouillage radioélectrique à l'intention des autres utilisateurs, il faut choisir le type d'antenne et son gain de sorte que la puissance isotrope rayonnée équivalente (p.i.r.e.) ne dépasse pas l'intensité nécessaire à l'établissement d'une communication satisfaisante. La puissance de sortie maximale plus gain d'antenne maximal du EUT est : 4.5W/m² Limite est 10W/m²

Battery Disposal

Only dispose of used batteries according to instructions and/or your local regulations.



Acknowledgments:

DASCOM is a registered trademark of DASCOM Europe GmbH

Bluetooth is a registered trademark of Bluetooth SIG, Inc.

Zebra, CPCL and ZPL are registered trademarks of Zebra Technologies

Wi-Fi is a registered trademark of the Wi-Fi Alliance

Windows is a registered trademark of Microsoft Corporation

All other trademarks are the property of their respective owners.

© 2017 by DASCOM. All rights reserved.

TABLE OF CONTENTS

Introduction	1
Printer Features	2
Quick Start Instructions	3
A. Paper Load (Media 8.5”).....	3
B. Battery Installation.....	4
C. Charge Battery.....	4
D. Power On.....	4
E. Control Panel.....	5
F. Performing a Printer Self-Test.....	6
G. Restore the Printer Firmware.....	6
Configuration	7
A. Connectivity Parameters.....	9
B. Image Parameters.....	14
C. Device Config.....	15
D. Fonts.....	19
E. Image Config.....	20
F. Graphics.....	24
G. Update Printer Firmware, Upload Files to Printer Memory.....	26
H. Reset Printer Configuration to Factory Defaults (Safe Mode).....	27
Printing Modes	28
A. ASCII Based Print Jobs.....	28
B. Graphic Based Print Jobs.....	28
Integrating the Printer into your Business Applications	
Step by Step – Creating a Link from Host to Printer	29
A. Windows Desktop Computers.....	29
Print Drivers.....	29
I. USB.....	29
II. Bluetooth – General.....	34
III. Bluetooth – Windows 7 and above.....	34
Ethernet Drivers.....	35
I. Install Win XP Ethernet Driver.....	35
II. Manually install Win 7/8 Ethernet Driver.....	40

III. Install Win 10 Ethernet Driver.....	44
IV. Wi-Fi.....	47
B. Windows Tablets and Smartphones.....	47
C. Android Tablets & Smart phones.....	47
I. Bluetooth.....	47
II. Wi- Fi.....	48
D. Apple™ Tablets & Smartphones.....	48
IV. Bluetooth.....	48
V. Wi-Fi.....	48
Media.....	49
A. Standard Media.....	49
B. Black Mark Media Position.....	49
Maintenance and Troubleshooting.....	50
A. Cleaning.....	50
B. Battery Care.....	50
I. Storage.....	50
II. Getting the Maximum Battery Life.....	51
III. Charging the Battery.....	51
IV. Additional Battery and Safety Information.....	51
V. Testing the Power Adapter and Battery.....	52
C. Troubleshooting.....	52
I. General Error Conditions.....	53
II. Fault Description and Resolution.....	53
D. Obtaining Service.....	55
APPENDIX.....	56
A. Appendix A – DP-581 Printer Specifications.....	56
Glossary of Terms.....	57
Index.....	59

Introduction

Thank you for purchasing the DP-581 Series mobile thermal printer also referred to in this manual as the “DP-581”. The DP-581 series prints on special thermal media supplied in roll form up to 8 inches wide. All models are equipped with a USB port which supports cabled communications. All models support an optional internal Bluetooth or Wi-Fi interface. Complete specifications may be found in [Appendix A – DP-581 Printer Specifications](#).

The remainder of this manual focuses on preparing the printer for initial use and performing tasks that will be encountered during daily use.

[Maintenance and Troubleshooting](#) describes how to maintain the printer for optimal performance and has information on how to diagnose any problems that may occur.

Printer Features

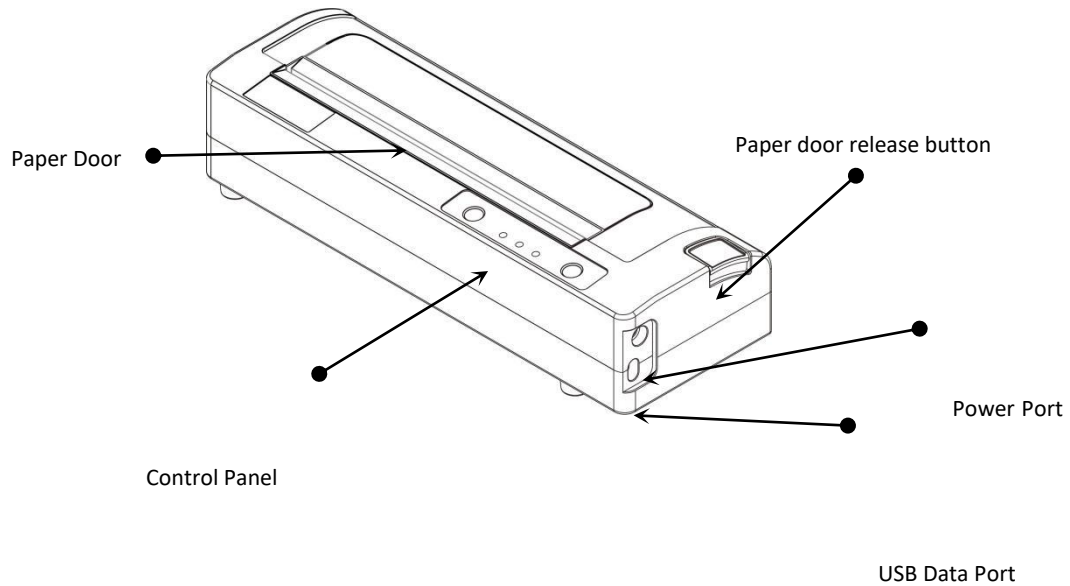

Your DP-581 features:

- Easy-to-read control face and simple drop-in paper loading
- Quickly prints a wide variety of tickets, and receipts.
- Extensive fonts, character sets, bar codes and graphic capabilities
- Printing speed up to 11 pages per minute.
- Printer configuration is quick and easy with a web based interface
- The latest in battery technology provides for full-shift printing in all modes
- Compatible with Windows, and Android
- Emulations that allow the printer to be a drop-in replacement for nearly any mobile printer

For detailed specifications reference [Appendix A – DP-581 Printer Specifications](#).

Quick Start Instructions

A. Paper Load (Media 8.5”)

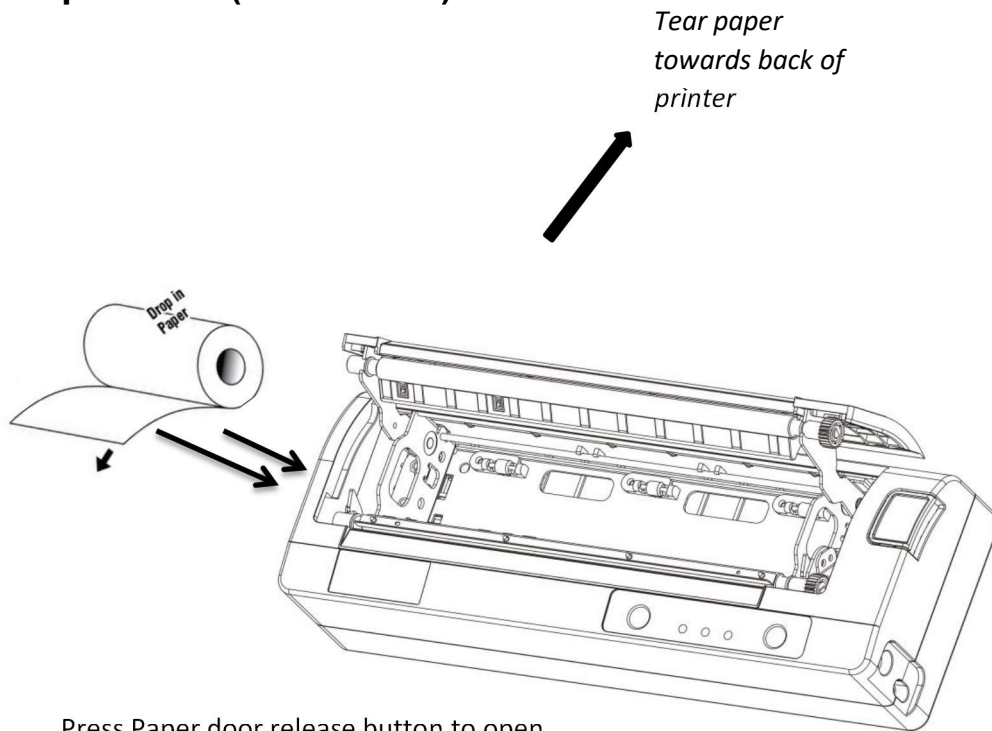

Press Paper door release button to open the paper compartment door. Pull small leader of paper out and close paper door. “ Clicks” when properly closed.

NOTE:
When using A4 paper, install spacer

Media 8”

Before loading 8 inch media, users could install a pair of spacers into the compartment so as to secure the media.

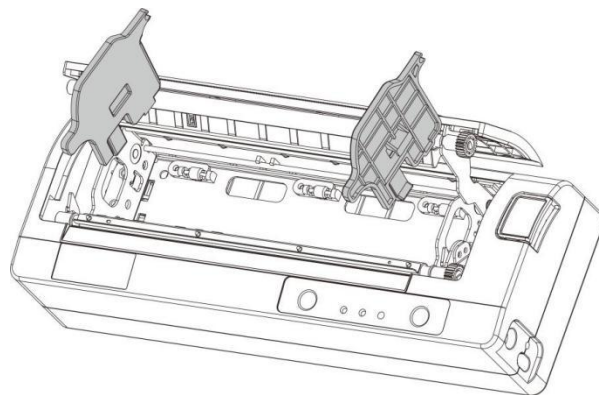

B. Battery Installation

Press button to see battery charge level.

4LED 100% charge

3LED 75%

2LED 50%

1LED 25%

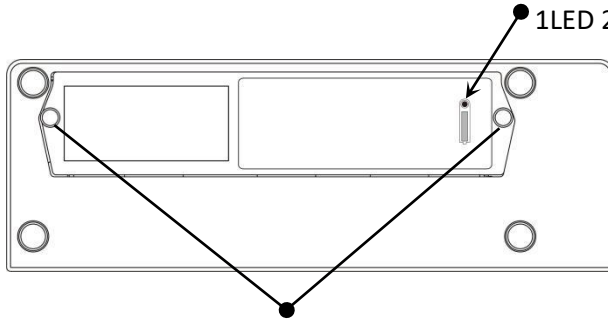

Remove the two screw and remove the battery.

Disposal

Please dispose the batteries separately and free of cost at your sales agency or the designated local collecting points.

Therefore please consider the national recycling standards!

Disassembly and removal of the batteries are described in the User Guide.

C. Charge Battery

Uncover the printer ports and plug in your AC power adapter to the Power port (must be a Dascom-supplied accessory). The yellow LED will show solid ON while the printer battery is charging.



NOTE: Charge via USB is not supported, please do not charge via the USB-C port.



D. Power On

Depress the Power button on the control panel. The green LED and the red LED will both be lit while the printer is going through its startup sequence (about 20 seconds). The red LED will go off, leaving the green LED on to indicate the printer is ready to print.

When battery volume goes below 15% or the battery voltage is less than 9 V, the printer will shut down itself. When it's below 20% or the battery voltage is less than 9 V, it will flash yellow LED as an alarm of low battery.

E. Control Panel

Control Panel		
 Power Button	Power Up Power Down Toggle IP over USB on/off	Press & Release Press & Hold Press twice
 Paper Feed Button	Advance paper Print Setup Report	Press once Press twice

Power & Status (Green/Red) 	Battery (Yellow) 	Alert (Red) 	Indication
On	Off	On	Booting up
On	Off	Off	Ready
On	Off	Flashing	Paper Error / Lid Open / Paper End
Flashing	Off	Off	Job is arriving
Flashing	Off	Off	Job is printing
Flashing	Off	Flashing	IP over USB active
	On		Charging Battery
	Flashing		Battery Low
Flashing	Flashing	Flashing	Restart the printer manually
Off	Off	Flashing	Restore the printer firmware
Off	Off	On	Print head too hot

F. Performing a Printer Self-Test



Before you connect the printer to the computer, make sure that the printer is in proper working order.

You can do this by printing a configuration status label.

1. Make sure the media is properly loaded, the top cover of the printer is closed and the printer is power on. Then, press the Feed button twice continuously.
2. The printer will print out a parameter setting page.

G. Restore the Printer Firmware

1. When the Power & Status LED is off, and Alert LED flashing, you need to restore the printer firmware. Turn on the printer and wait for around 30 seconds, the printer enters into configuration mode, and you could download the firmware via web.
2. If any problem occurs during firmware upgrade, and the printer fails to work, you could restore the printer firmware as such:
 - ① You had better use external battery.
 - ② Turn on the printer by holding both the feeding button and power button for five seconds.
 - ③ With Power LED and Alert LED flashing, the printer enters into Configuration mode after 30 seconds.
 - ④ You could upgrade the firmware via the web.

Configuration

Configuration of the DP-581 printer is done through a built-in web page. This allows you to configure the printer from any device that has a browser and is compatible with your DP-581 communication capabilities.

1. Turn the printer ON.
2. Connect a USB cable between the printer and a PC.
3. To access the DP-581 web page, push the Power button twice rapidly. This will put the printer into Configuration mode.
4. When the printer is in Configuration mode the POWER and FAULT LEDs will flash together.
 - a. Open browser on your PC and type **169.254.200.1** into the address bar of the browser and hit Enter - A login box should appear:

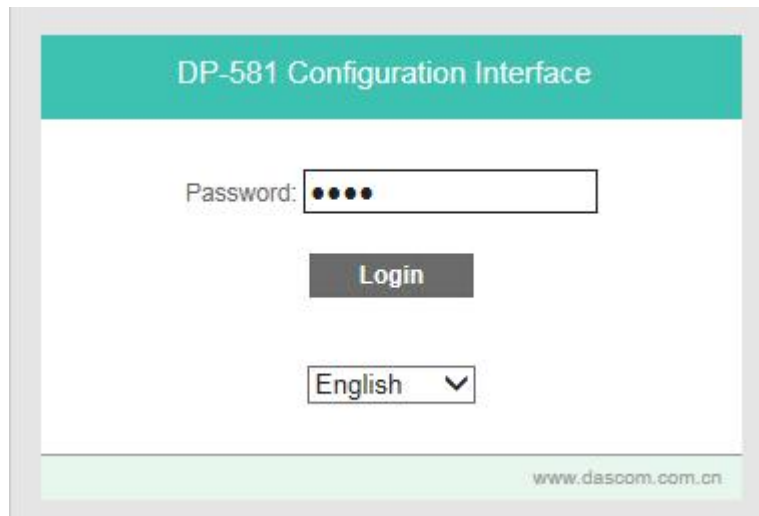

- b. Type "0000" and hit Enter- you should now be at the home page for DP-581 Configuration.

5. The main configuration screen of the DP-581:

The screenshot shows the main configuration screen of the DP-581 printer. At the top, there is a navigation bar with links: Main, WIFI Config, Image Config, Device Config, Fonts, Graphics, Updates, and Reset To Factory Defaults. Below this is a header for 'Current 123456789022 Configuration' with a gear icon. The main content area is divided into several sections:

- Printer Info:** Model: DP-581, Primary SW Version: beta01.10.00.00, CoProcessor SW Version: 01.05.00.00, Print head recode: 195.14 w.
- WIFI Config:** Address Method: DHCP, IP Address: 0.0.0.0, SubnetMask: 0.0.0.0, Gateway: 0.0.0.0, Connection: Printer.
- Image Config:** Emulation: ESCPOS, Font Type: Font A, Choose Font Type: Font A, Default Line Spacing: 30.
- Device Config:** Max Paper Speed: 76.2, Mark Sens: ON, Front Paper Sensor Threshold: 99%, Rear Paper Sensor Threshold: 99%, Gap Paper Sensor Threshold: 25%, Stop Distance after Mark: 6 mm, Mark Width: 3 mm, Mark print location: 20 mm, Mark cut location: 70 mm, Backup Distance Before Printing: 0.0 mm, Feed Distance After Printing: 0 mm, Left Margin: 3 mm, Contrast: 5.
- Storage:** Total Flash: 215 MB, Used: 134 MB (62%), Free: 82 MB.
- Installed Fonts:** A list of 26 fonts including Arial, Dancing Script, HAN NOM A, HAN NOM A, and various Liberation Mono and Sans fonts.
- Installed Logos:** A section for installed logos.

On the right side, there is a 'Print Test Page' button, a 'View/Hex Dump' section with 'enable' checked, and a 'Service and Support' section with a link to the user manual.

This is an overview of the printer configuration. The battery icon shows the relative charge in the battery. The more bars, the higher the charge. An AC plug will appear in the battery icon when the printer is plugged into an external power source.

To return the printer to normal operating mode, double-click the Power button. The POWER LED will be returned to a solid light.

At the top of the Main Page are selections to access the sub-menus.



Click "User Manual" to access the user manual pages for help.

A. Connectivity Parameters

This page allows you to setup the connection to your printer. Depending on the optional interface installed, you will see either Bluetooth Config or WI-FI Config. In the detailed descriptions, an asterisk (*) indicates the factory default value.

Bluetooth Config

The screenshot shows the 'Bluetooth Config' page of the Tally DASCOM printer's web interface. The page has a light green background. At the top left is the 'Tally' logo in blue and the 'DASCOM' logo in purple. Below the logos is a navigation menu with links: Main, Bluetooth Config (active), Image Config, Device Config, Fonts, Graphics, Updates, and Reset To Factory Defaults. The main heading is 'Bluetooth Config' with a gear icon. The configuration area is a white box containing the following fields and options:

- Local Name:
- MAC ADDRESS: 00:1A:7D:DA:70:01
- Paired Mode: UnPaired Paired
- Discoverability: Off On
- Pin:
- Connection: Printer Personal Area Network
- Note: Submit Changes will force restart.
- Buttons: Submit Changes, Discard Changes

Paired Mode:

Possible values: UnPaired, Paired*

This feature allows Bluetooth pairing to occur between the printer and the connecting device whenever Pairing is required by either device. Pairing requires that the PIN on the printer and the connecting device exactly match each other.

Discoverability:

Possible Values: Off, On*

This feature is used to set whether the printer may be discovered by other Bluetooth devices. It should only be set to "Off" after the printer has been discovered and paired with a host computer.

PIN:

Possible Values: 0000*, Up to 16 Numeric Characters.

Note that this feature is only available if Pairing Mode is set to "Paired". The PIN value must exactly match the PIN value set in the Bluetooth manager on the host computer.

Connection:

Possible Values: Printer*, Personal Area Network

This feature selects the role of the printer's interface in the Bluetooth network.

In Printer mode, the printer behaves as a regular Bluetooth device.

In Personal Area Network mode, the printer behaves similar to a Wi-Fi access point.

The Power LED will flash off every two seconds while in this mode.

After pairing with the printer, the host Bluetooth icon will appear different, indicating that an access point is present.



Some hosts require an extra connect step after pairing. After connecting, the printer will issue an IP address to the host and the host can communicate to the printer as if it were a Wi-Fi printer. The printer's address to the host is always **169.254.200.1**.

In the host device's browser (if equipped) this address may be entered in the address bar to access the printer web page.

Personal Area Network mode can also be activated outside of the printer web page.

To enter Personal Area Network mode, press and hold the Power and Paper Feed buttons until the Power and Alert LEDs light. Release both buttons, and the printer will restart in Personal Area Network mode. To exit Personal Area Network mode, press and hold the Power and Paper Feed buttons until the Power and Alert LEDs light. Release both buttons, and the printer will restart in normal Bluetooth mode.

WI-FI Config:

The screenshot shows the Tally DASCORM printer web interface. The top navigation bar includes links for Main, WIFI Config, Image Config, Device Config, Fonts, Graphics, Updates, and Reset To Factory Defaults. The current page is titled "Wireless Configuration" and features a table with the following content:

Address Method	<input type="radio"/> Static <input checked="" type="radio"/> DHCP <input type="radio"/> Access Point
Wifi Port	8023

Below the table, a note states: "Note: Submit Changes will force restart." At the bottom, there are two buttons: "Submit Changes" and "Discard Changes".

Wireless Configuration

This will display the current Wi-Fi configuration:

IP Address – user defined. If Static Address Method is selected, type in the address the printer will use on the network.

SubNetMask – user defined. If Static Address Method is selected, type in the subnet mark of the network.

GateWay – user defined. If Static Address Method is selected, type in the gateway address of the network.

WiFi Port – default value = 8023

Address Method – user selectable

Static – printer will always connect to the network using the IP address defined.

DHCP – printer will acquire an IP address from your network DHCP server

Access Point – printer will acquire an IP address from your WiFi access point

Personal Area Network –The printer will broadcast itself as a network connection. The Power LED will flash off every two seconds while in this mode. The SSID will be the serial number of the printer.

When connecting to the printer, the passphrase is the printer's serial number.

Personal Area Network mode can also be activated outside of the printer web page.

To enter Personal Area Network mode, press and hold the Power and Paper Feed buttons until the Power and Alert LEDs light. Release both buttons, and the printer will restart in Personal Area Network mode. To exit Personal Area Network mode, press and hold the Power and Paper Feed buttons until the Power and Alert LEDs light. Release both buttons, and the printer will restart in normal Wi-Fi mode.

Current Connection

Status	IP Address
SCANNING	

show details | hide details

Previously Connected Networks

Network ID	SSID	BSSID	Status	Connect/Disconnect	Remove
0	Testing	any		<input type="button" value="Connect"/>	<input type="button" value="Remove"/>

Available Networks

BSSID	Frequency	Signal Level	Flags	SSID	Add/Connect
74:a5:28:0e:1a:de	2437	193	[WPA2-PSK-CCMP][ESS]	66	<input type="button" value="Add/Connect"/>
00:36:76:1b:49:ec	2462	186	[WPA-PSK-CCMP][WPA2-PSK-CCMP][ESS]	TEST	<input type="button" value="Add/Connect"/>
00:36:76:19:c0:b8	2462	189	[WPA-PSK-CCMP][WPA2-PSK-CCMP][ESS]	cannary	<input type="button" value="Add/Connect"/>
6c:19:8f:c4:68:54	2427	199	[WPA-PSK-TKIP+CCMP][WPA2-PSK-TKIP+CCMP][WPS][ESS]	jishu	<input type="button" value="Add/Connect"/>
c0:a0:bb:c5:a3:78	2412	200	[WPA-PSK-TKIP+CCMP][WPA2-PSK-TKIP+CCMP][ESS]	TP-LINK-I	<input type="button" value="Add/Connect"/>
f0:b4:29:37:d3:c5	2412	186	[WPA2-PSK-CCMP][ESS]		<input type="button" value="Add/Connect"/>
24:05:0f:88:9c:b4	2412	182	[WPA-PSK-CCMP][WPA2-PSK-CCMP][ESS]		<input type="button" value="Add/Connect"/>
64:09:80:0d:91:bb	2412	193	[WPA2-PSK-CCMP][ESS]	MH	<input type="button" value="Add/Connect"/>
00:36:76:3f:57:cf	2437	181	[WPA-PSK-CCMP][WPA2-PSK-CCMP][ESS]	R600	<input type="button" value="Add/Connect"/>
00:36:76:54:ff:7f	2412	183	[WPA-PSK-CCMP][WPA2-PSK-CCMP][ESS]		<input type="button" value="Add/Connect"/>
18:59:36:7e:59:16	2437	183	[WPA2-PSK-TKIP][ESS]	HM NOTE 1LTE	<input type="button" value="Add/Connect"/>
58:69:6c:45:07:98	2462	171	[WPA2-PSK-TKIP+CCMP][ESS]	Dascom111	<input type="button" value="Add/Connect"/>
5a:69:6c:44:07:98	2462	168	[WPA2-PSK-TKIP+CCMP][ESS]	Dascom333	<input type="button" value="Add/Connect"/>
bc:46:99:0d:8a:88	2437	172	[WPA-PSK-CCMP][WPA2-PSK-CCMP][ESS]	csjm-citizen	<input type="button" value="Add/Connect"/>

Available Networks – access points detected by the printer will be displayed. Select Add/Connect to use one of these access points.

Previously Connected Networks – access points detected by the printer or added through Add/Edit Network will be displayed. Select Connect to use one of these access points, or Remove to delete it from printer.

Currently Configured Networks – access points added through Add/Edit. They may not have been connected yet. Select Remove to delete access point from printer.

Add/Edit Network

Enter the SSID of a network connection. If authentication is used select the authentication type. Click Next. The following form will change depending on the authentication type:

WPA-PSK

Enter the password for the network connection.

The screenshot shows a printer's network configuration interface. At the top, there is a 'Current Connection' section with a 'Status' of 'SCANNING' and an 'IP Address' field. Below this are 'show details' and 'hide details' buttons. The 'Previously Connected Networks' section contains a table with one entry: Network ID 0, SSID 'Testing', BSSID 'any', and a 'Connect' button. The 'Available Networks' section is a table with columns: BSSID, Frequency, Signal Level, Flags, SSID, and Add/Connect. A modal dialog box is open over the 'Available Networks' table, showing a 'Password:' label, an input field, and a 'Connect' button. The table lists various networks with their BSSIDs, frequencies, signal levels, flags, and SSIDs.

BSSID	Frequency	Signal Level	Flags	SSID	Add/Connect
74a5:28:0e:1a:de	2437	204	[WPA2-PSK-CCMP][ESS]	66	Add/Connect
00:36:76:1b:49:ec	2462	195	[WPA-PSK-CCMP][WPA2-PSK-CCMP][ESS]	TEST	Add/Connect
00:36:76:19:c0:b8	2462	189	[WPA-PSK-CCMP][WPA2-PSK-CCMP][ESS]	cannary	Add/Connect
6c:19:8fc4:68:54	2427	195	[WPA-PSK-TKIP+CCMP][WPA2-PSK-CCMP][ESS]	jishu	Add/Connect
c0:a0:bb:c5:a3:78	2412	190	[WPA-PSK-TKIP+CCMP][WPA2-PSK-CCMP][ESS]	TP-LINK-1	Add/Connect
f0:b4:29:37:d3:c5	2412	196	[WPA2-PSK-CCMP][ESS]		Add/Connect
24:05:0f:88:9c:b4	2412	186	[WPA-PSK-CCMP][WPA2-PSK-CCMP][ESS]		Add/Connect
64:09:80:0d:91:bb	2412	188	[WPA2-PSK-CCMP][ESS]	MH	Add/Connect
00:36:76:3f:57:cf	2437	179	[WPA-PSK-CCMP][WPA2-PSK-CCMP][ESS]	R600	Add/Connect
00:36:76:54:4f:7f	2412	174	[WPA-PSK-CCMP][WPA2-PSK-CCMP][ESS]		Add/Connect
18:59:36:7e:59:16	2437	176	[WPA2-PSK-TKIP][ESS]	HM NOTE LTE	Add/Connect
58:69:6c:45:07:98	2462	171	[WPA2-PSK-TKIP+CCMP][ESS]	Dascom111	Add/Connect
5a:69:6c:44:07:98	2462	166	[WPA2-PSK-TKIP+CCMP][ESS]	Dascom333	Add/Connect
bc:46:99:0d:8a:88	2437	173	[WPA-PSK-CCMP][WPA2-PSK-CCMP][ESS]	csjm-citizen	Add/Connect

WPA-EAP or IEEE8021X

These are Enterprise network settings. Consult your server manual for recommended settings.

The image shows a web-based configuration interface with three main sections:

- Add Personal Network:** Contains fields for SSID and Password, an Authentication dropdown menu (with options: No Authentication, WPA-Personal(PSK), WPA2-Personal(PSK), Static WEP(no authentication)), and an Encryption dropdown menu (with option: TKIP). A Submit button is at the bottom.
- Add Enterprise Network:** Contains fields for SSID and Password, an Authentication dropdown menu (with options: Static WEP(Shared Key), IEEE 802.1X, WPA-Enterprise(EAP), WPA2-Enterprise(EAP)), an Encryption dropdown menu (with option: TKIP), and an Identity field. A Submit button is at the bottom.
- Upload Digital Certificate:** Contains a label 'Filename:', a text input field, a 'Browse...' button, and an 'Upload' button.

Upload Digital Certificate

If your enterprise network uses digital certificates as another form of authentication, you can upload the certificates here.

B. Image Parameters

This page allows you to make selections about the image to be printed.

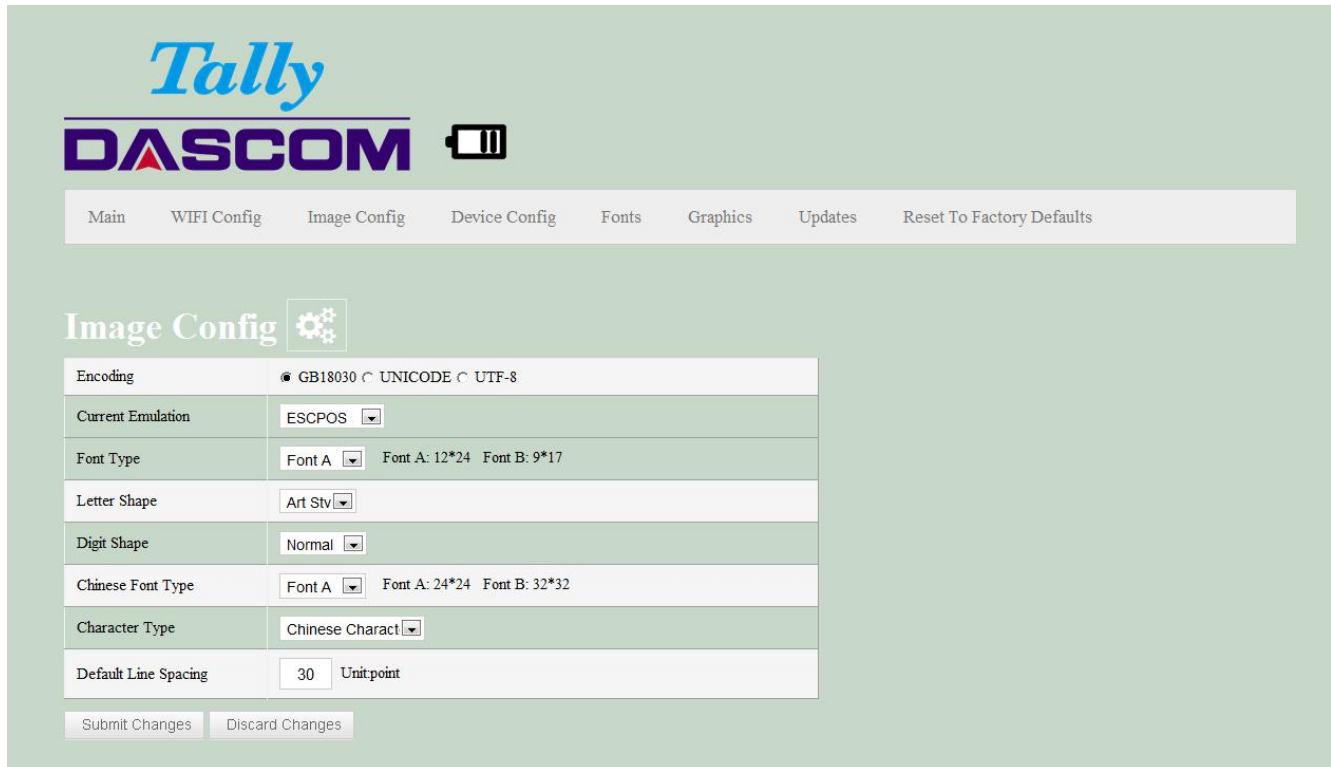

The screenshot shows the 'Image Config' page of the Tally DASCOM printer interface. The page has a navigation bar with the following links: Main, WIFI Config, Image Config, Device Config, Fonts, Graphics, Updates, and Reset To Factory Defaults. The 'Image Config' section is highlighted and contains a settings table:

Encoding	<input checked="" type="radio"/> GB18030 <input type="radio"/> UNICODE <input type="radio"/> UTF-8
Current Emulation	ESCPOS
Font Type	Font A Font A: 12*24 Font B: 9*17
Letter Shape	Art Stv
Digit Shape	Normal
Chinese Font Type	Font A Font A: 24*24 Font B: 32*32
Character Type	Chinese Charact
Default Line Spacing	30 Unit:point

At the bottom of the form, there are two buttons: 'Submit Changes' and 'Discard Changes'.

Current Emulation:

Possible Values: PRINTEK*, ZPL, CPCL, ESCPOS, AUTOIMAGE, PDF, POSTSCRIPT, IMAGE

The DP-581 printer is capable of using several different emulation modes. This feature sets the family of printer commands that may be used by a host application program to control the various capabilities of the printer. The printer will only respond to commands valid for the currently selected emulation. For more information, please refer to the *Integrator's Guide*.

Besides the popular printer languages to choose from, the following selections allow the DP-581 to print many other file formats directly, without the need for a driver.

AUTOIMAGE – selected when mixed PDF and POSTSCRIPT images are sent to the printer. The printer will determine which type of file has been sent. This can increase printer response time.

PDF – When in this mode the printer will directly print Portable Document Files (PDF).

POSTSCRIPT – When in this mode the printer will directly print Postscript formatted files (.ps). You can also use a generic Postscript driver to print when in this mode.

IMAGE – selected if just image files are being sent to the printer. When in this mode the printer will directly print the following file types: .png, .jpg, .bmp, .pbm, .svg, .tif

Default Font:

The DP-581 has the ability to use True Type Fonts. All True Type Fonts loaded into printer memory are listed here. When using emulations that do not specify the font for each line of text, select the font you would like to use as the default font. All print jobs will use the default font unless a command is sent to the printer to use another font.

Chars Per Inch and Default Text Line Spacing:

This determines how large the characters are and how many characters will print in a one inch space. The higher the number, the greater the number of lines per vertical inch of print.

C. Device Config

This page allows you to set certain hardware parameters on the printer.

The screenshot shows the 'Device Config' page for a Tally DASCOM printer. The page has a navigation menu with options: Main, Bluetooth Config, Image Config, Device Config (selected), Fonts, Graphics, Updates, and Reset To Factory Defaults. The 'Device Config' section is titled 'Form' and contains a table of settings:

Units	mm
Max Paper Speed	76.2 mm per sec.
Mark Seek	<input checked="" type="radio"/> RollPaper <input type="radio"/> BlackMarkPaper <input type="radio"/> CutSheetPaper
Front Paper Sensor Threshold	90 % range 0-100%
Backup Distance Before Printing	0 mm
Feed Distance After Printing	40 mm
Left Margin	0 mm
Contrast	5 1 - 10
Power Sleep	Disabled min(s)

Below the table is a 'Paper Sensitivity' section with 'Thermal paper settings' that are 'Locked'. It includes a 'Thermal paper type' dropdown menu set to '7'. At the bottom of the page are 'Submit Changes' and 'Discard Changes' buttons.

Units

Select between inches or millimeters. If you change units, do so before entering other settings.

Max Paper Speed

Possible values: 25.4 to 76.2 mm, Default = 76.2

When using labels or heavy paper stock, you may need to decrease the paper speed to prevent paper jams.

Mark Seeking

Possible values: RollPaper, black mark paper, and cut sheet paper.

Set the value when using regular or label media with black alignment marks or label media with gaps between the labels

Note: Before adjusting black mark thresholds, set Mark Width to match the width of the black mark or label gap on your media.

Paper Sensor Threshold

When using paper with a black on the front adjust this setting to insure the paper stops at the black mark.

1. Set paper sensor threshold: white paper has relatively smaller sensor brightness while black paper has relatively bigger sensor brightness. When sensor brightness is bigger than paper sensor threshold, printer could detect black mark. Otherwise, printer could not detect black mark. In latter case, users have to lower paper sensor threshold. For example, when printer stops in the middle of white paper, users could increase the paper sensor threshold. The recommended value is between 75% ~ 95%.
2. Close lid and press paper feed. The paper should stop with the bottom of the form at the tear bar.

Backup Distance Before Printing

Used with Mark Seek. User defined. This is the distance the printer will pull in the paper before starting to print.

Feed Distance After Printing

Used with Mark Seek. User defined.

Mark Seek Distance

Used with Mark Seek. User defined. This is the distance the printer will advance paper to seek the mark before displaying a Paper Out condition.

Stop Distance After Mark

Use with Mark Seeking. User defined. This is the distance the printer will advance the paper after the mark is detected.

Mark Width

Use with Mark Seeking. User defined.

Left Margin

Setting this value will tell the printer how far from the left edge of the paper to start the print job.

Contrast

Possible values 0 – 10. Default value is 5

The lower the value the lighter the print. The higher the value the darker the print.

Thermal Paper Type

This is a locked value. These settings are supplied by the paper manufacturer. The default settings cover most grades of paper. If you are using non-standard paper consult the paper manufacturer for recommended settings.

NO.	Standard printing energy (mJ)	Less than 25~C	25~C or higher
1	0.2998	0.003666	0.003666
2	0.3074	0.001384	0.003838
3	0.3126	0.000957	0.003835
4	0.3134	0.003714	0.00339
5	0.327	0.001291	0.003487
6	0.3458	0.005085	0.004132
7	0.3678	0.005231	0.005231
8	0.3689	0.004347	0.0049
9	0.3696	0.000932	0.004887
10	0.3725	0.00219	0.004733
11	0.3821	0.002577	0.004581
12	0.3901	0.002321	0.004551
13	0.3972	0.002115	0.004878
14	0.4009	0.005592	0.005199
15	0.4087	0.004228	0.004899
16	0.4235	0.001842	0.005624
17	0.4848	0.00296	0.004133
18	0.5687	0.002823	0.006054

Power sleep

Possible values: **Disabled, 10, 30, 60, 120, 180** minutes. Default value is **Disabled**.

This timer will turn the printer off if it has not been used for the time set. Disable this feature by setting the time at **Disable**.

D. Fonts

Font Family Name	Index	Indicator(System default fonts, which cannot be removed.)
SimHei	A	*
Andika Basic	B	*
Liberation Mono	C	*
MICR	D	*
Instruction	E	*
Liberation Sans	F	*
OCRA	G	*
SimSun	H	*
HAN NOM A	I	*
Liberation Serif	J	*
VCR OSD Mono	K	*
Dancing Script	L	*
Atrian 3	M	*
OCR B Std	N	*

Upload Font File

Truetype Fonts (.ttf, .otf, .ttc and .bdf) can be uploaded here.

Languages like ZPL and CPCL can use the fonts by referring to them by their Font Family Name.

E. Image Config

User Define ESCPOS fonts

Enter Image Config – Current Emulation to set ESCPOS emulation fonts.

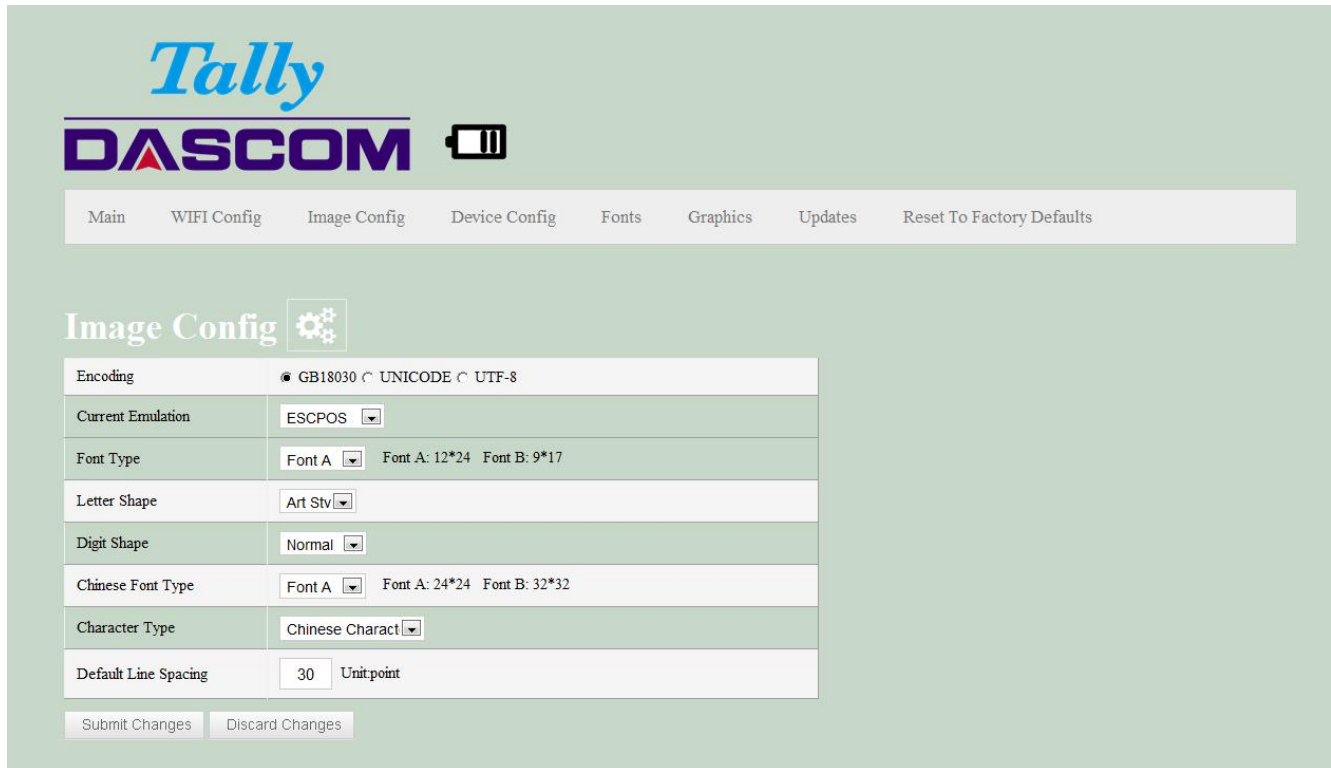

The screenshot displays the 'Image Config' web interface for a Tally DASCOM device. The interface includes a navigation menu with options: Main, WIFI Config, Image Config, Device Config, Fonts, Graphics, Updates, and Reset To Factory Defaults. The 'Image Config' section is active, showing a settings table with the following configurations:

Encoding	<input checked="" type="radio"/> GB18030 <input type="radio"/> UNICODE <input type="radio"/> UTF-8
Current Emulation	ESCPOS
Font Type	Font A (Font A: 12*24 Font B: 9*17)
Letter Shape	Art Stv
Digit Shape	Normal
Chinese Font Type	Font A (Font A: 24*24 Font B: 32*32)
Character Type	Chinese Charact
Default Line Spacing	30 Unitpoint

At the bottom of the configuration area, there are two buttons: 'Submit Changes' and 'Discard Changes'.

User Define Western Fonts

Font A:

Font A: Letters and numbers print in FontA by default. The parameter of FontA is 12 * 24. For letters you could choose among three types of typeface: art font, Song, equal-line face.

For numbers you could choose among three types of typeface: normal, bank, and OKI numbers. (If the command entails changing the font, the printer will use specific font.)

Letters

Art Font	ABCDEFghijk
Song	ABCDEFghijk
Equal-line face	ABCDEFghijk

Numbers

Normal	1234567890
Bank	1234567890
OKI number	1234567890

Font B: Letters and numbers print in FontB by default. The parameter of FontA is 9 * 17. Use system default font and cannot be changed.

Printout:

fontA: ABCDEFghijk

fontB: ABCDEFghijk 1234567890

User-defined: Users could change the size and font, using the system font and uploaded fonts. (If the command entails changing the font, the printer will use specific font.)

eg:

User-defined: 9 pounds. Western font file: STHUPO.TTF

ABCDEFghijk 1234567890

User Define Chinese Fonts

Font A: set in default. Parameters: 24 * 24. Use system default font and cannot be changed.

Printout:

中文字体 FontA

Font B: set in default. Parameters: 32 * 32. Use system default font and cannot be changed.

Printout:

中文字体 FontB

User-defined: Users could change the size and font, using the system font and uploaded fonts. (If the command entails changing the font, the printer will use specific font.)

eg:

User-defined size: 9 pounds Western Font File: STHUPO.TTF

自定义中文字体

User Define PRINTEK Fonts

Enter Image Config – Current Emulation to set PRINTEK emulation fonts.

- (1) Default font: Liberation Mono:LiberationMono-Regular.ttf.
- (2) Selected font: OCRA:OCRA.ttf.

Liberation Mono:LiberationMono-Regular.ttf:

1B 40 2F 2A 2D 30 31 32

Printout:

33 34 35 36 37 38 39 3B

3A 3C 3D 3E 3F 40 41 42

@/*-0123456789;:<=>?@ABCDEFGHIJKLMNOPQRSTUVWXYZ

43 44 45 46 47 48 49 4A 4B

4C 4D 4E 4F 50 51 52 53 54

55 56 57 58 59 5A 0D 0A

OCRA:OCRA.ttf:

1B 40 2F 2A 2D 30 31 32
33 34 35 36 37 38 39 3B
3A 3C 3D 3E 3F 40 41 42
43 44 45 46 47 48 49 4A 4B
4C 4D 4E 4F 50 51 52 53 54
55 56 57 58 59 5A 0D 0A

Printout:

@/*-0123456789;:<=>?@ABCDEFGHIJKLMNPOQRSTUVWXYZ

User Define ZPL Fonts

- (1) Use CW command to define font.
- (2) CW command:
CW {font mark},R:{font file name} eg: CWL,R:simsun.ttf
- (3) CW command set font valid before printer restart.
- (4) User-defined font sample:

eg1:

^XA
Printout:
^CWL,R:simsun.ttf
^FO10,10
^ALN,70,30
^FDABCD123^FS
^XZ

ABCD123

eg2:

^XA
Printout:
^CWL,R:simhei.ttf
^FO10,10
^ALN,70,30
^FDABCD123^FS
^XZ

ABCD123

User Define CPCLFonts

- (1) Use TEXT command to define font.
- (2) TEXT command:
{command} {font} {size} {x} {y} {data}, {font}:font name/number; {size}:font size;

{x}: horizontal position; {y}: vertical position; {data}:printing data;
eg: TEXT 1 1 20 5 0123456789ABCDEFG

Sample:

eg1:

Printout:

! 0 200 200 300 1

TEXT 1 1 20 5 0123456789ABCDEFG

CENTER

PRINT

0123456789ABCD

eg2:

Printout:

! 0 200 200 300 1

TEXT 5 1 20 5 0123456789 ABCDEFG

CENTER

PRINT

0123456789ABCD

F. Graphics

This menu will allow you to load a graphics file into printer memory for use in creating your output. For instance, logos can be stored for recall and use by your host program (see *Integrator's Guide* for more details).

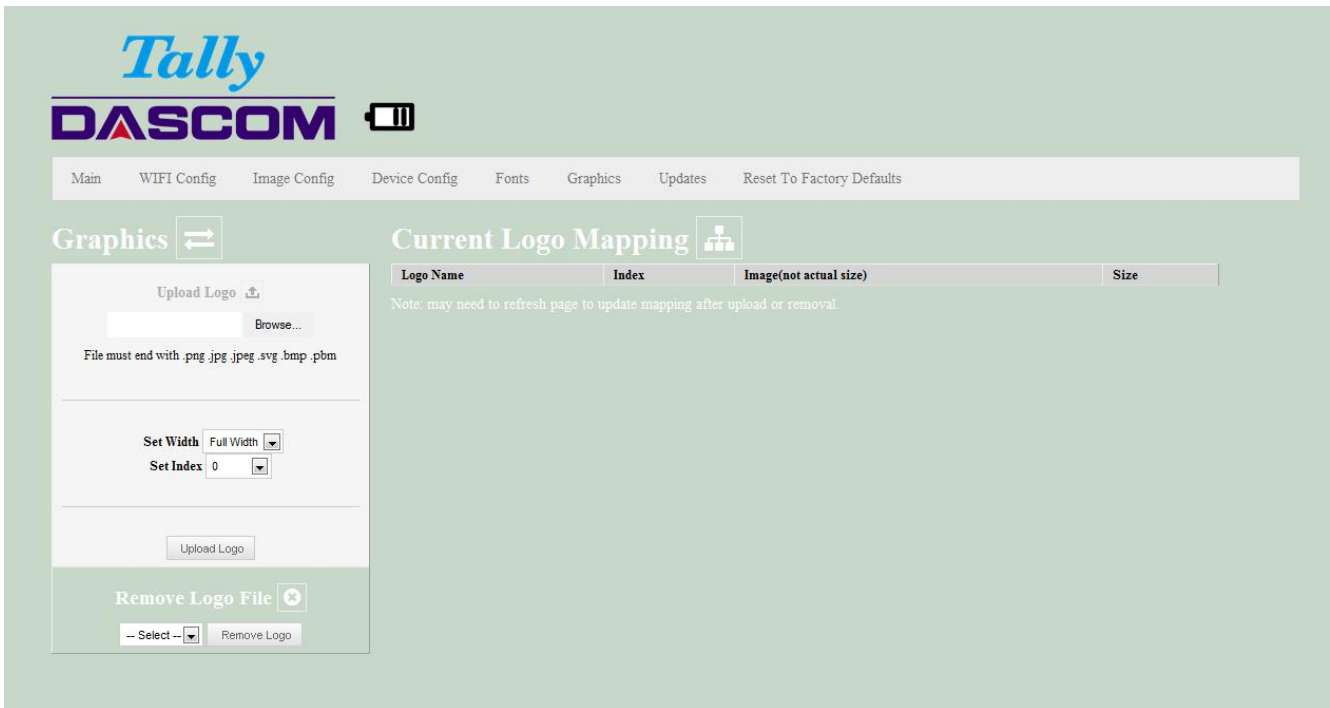

Upload File

Select the graphics file to load into printer memory. Acceptable graphics formats are .jpeg, .pbm, .pcx, .bmp, .png and .svg.

Set Width

Select the width you want to use to display your logo: full width, half width, or quarter width.

Set index

Depending on the Index value used, you can automatically print the graphics file as a header (prints at the beginning of the print job), footer (prints at the end of a print job) or use the graphics print command to print anywhere on your receipt or label. See *Integrator's Guide* for more information on graphics commands.

When selecting header, the graphics file will automatically print the logo at the beginning of each print job.

When selecting footer, the graphics file will automatically print the logo at the end of each print job.

You must set each of these values before selecting Upload Logo or the default values will be associated with your image.

Current Logo Mapping

Once uploaded into the printer memory, your image and settings will be displayed here.

Logo upload procedure: 1. Choose logo file, 2. Set the width, 3. choose the index. 4. Upload it

Delete logo procedure: 1. Choose logo 2. Delete it.

G. Update Printer Firmware, Upload Files to Printer Memory



Procedure:

1. Enter the config page
2. Click Updates.
3. Choose Upload Firmware, choose file and click Upload.
4. After uploading .tgz or .sw file, printer will restart itself. After uploading .fw file, the three LEDs will flash. Users should restart the printer.

Notice: If fail to upload firmware, which shows as alarm LED flash, power and charge LED off after printer on, users could upload the firmware again because the printer enters into configuration mode after charging for 30 seconds.

Printer Application Updates, OEM information and Manuals and more can be uploaded here. Contact Dascom retailer for more information.

H. Reset Printer Configuration to Factory Defaults (Safe Mode)

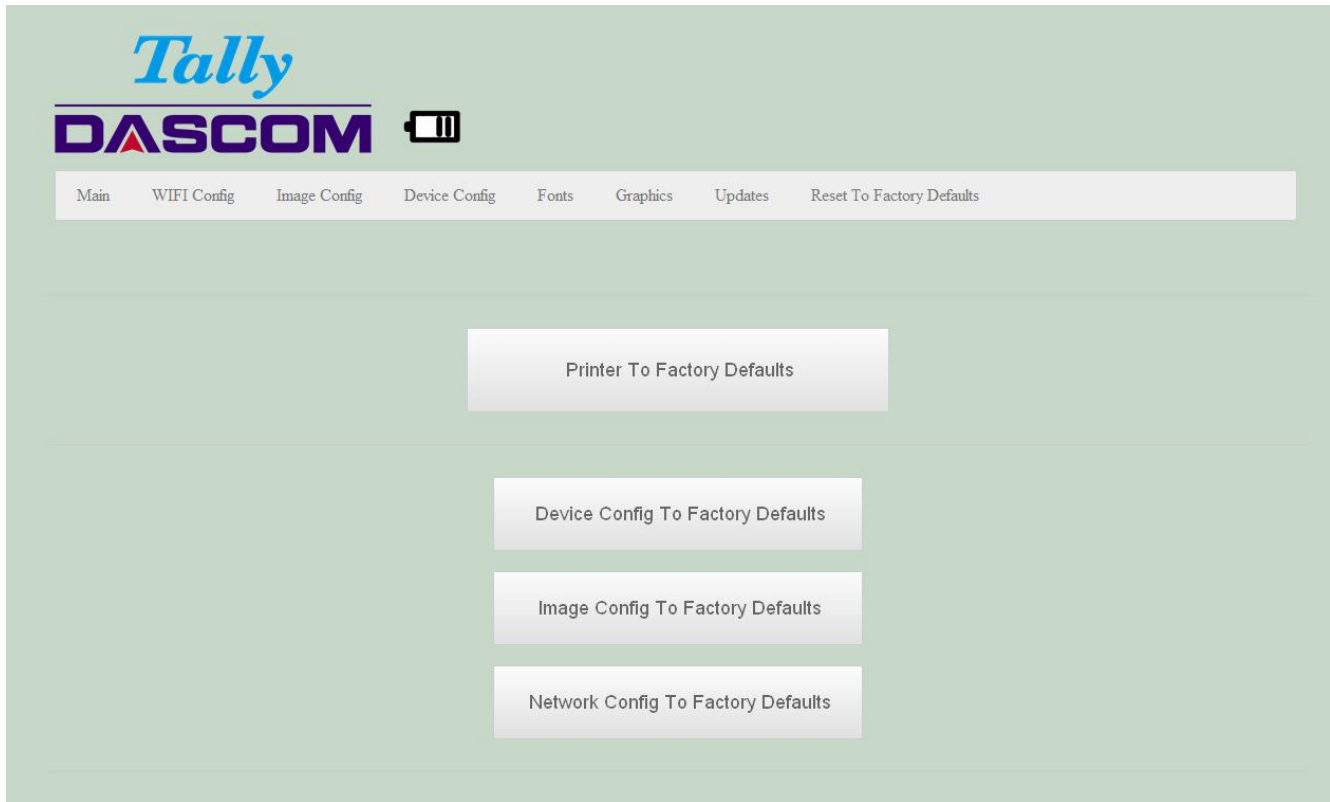

Printer to Factory Defaults: Printer settings can be restored to factory configurations.

Device Config to Factory Defaults: Printer settings can be restored to factory configurations.

Image Config to Factory Defaults: Printer emulation settings can be restored to factory configurations.

Network Config to Factory Defaults: WiFi and Bluetooth settings can be restored to factory configurations.

Note that WIFI network configurations will be lost when Network Config to Factory Defaults is checked.

Printing Modes

There are two fundamental printing modes with mobile printers.

A. ASCII Based Print Jobs

The host sends the print job as a series of lines of characters, some of which represent the text to be printed, while other portions are command codes which tell the printer which font to use, where to locate the text, what barcodes to use, etc. These text-based files are encoded in a print language specific to the target printer.

The DP-581 understands ASCII based jobs in several different print languages. Refer to the [Appendix](#) or the *Integrator's Guide* for the list of print languages supported.

B. Graphic Based Print Jobs

The host assembles the printed image as a series of lines of dots, and transmits this image as a sequence of data bytes that represent the dot patterns assembled. Often these jobs or files have some control characters on the front end and / or rear end of the dot pattern bytes to define their format, help control pagination, etc.

Windows drivers in particular encode the image as a graphic based print job before it is passed along to the printer.

In addition to accepting graphic jobs from its Windows driver, the DP-581 can accept and print directly many other graphic image file types. This opens up the option to print job images from a variety of devices for which drivers or print utilities don't exist, such as some tablets and smartphones.

Please see the *Integrator's Guide* or your system integrator for more details.

Integrating the Printer into your Business Applications Step by Step – Creating a Link from Host to Printer

A. Windows Desktop Computers

Print Drivers

The driver is the connection and transformation platform between the printer and the computer operating system to achieve the interactive processing of the information. User can set up relevant settings, get print status and etc. via driver.

The latest Windows printer drivers can be downloaded from our web:

<https://www.dascom.com/downloads.html>

I. USB

a) Install the printer driver onto your host before connecting the printer. Open DriverSetup.exe.

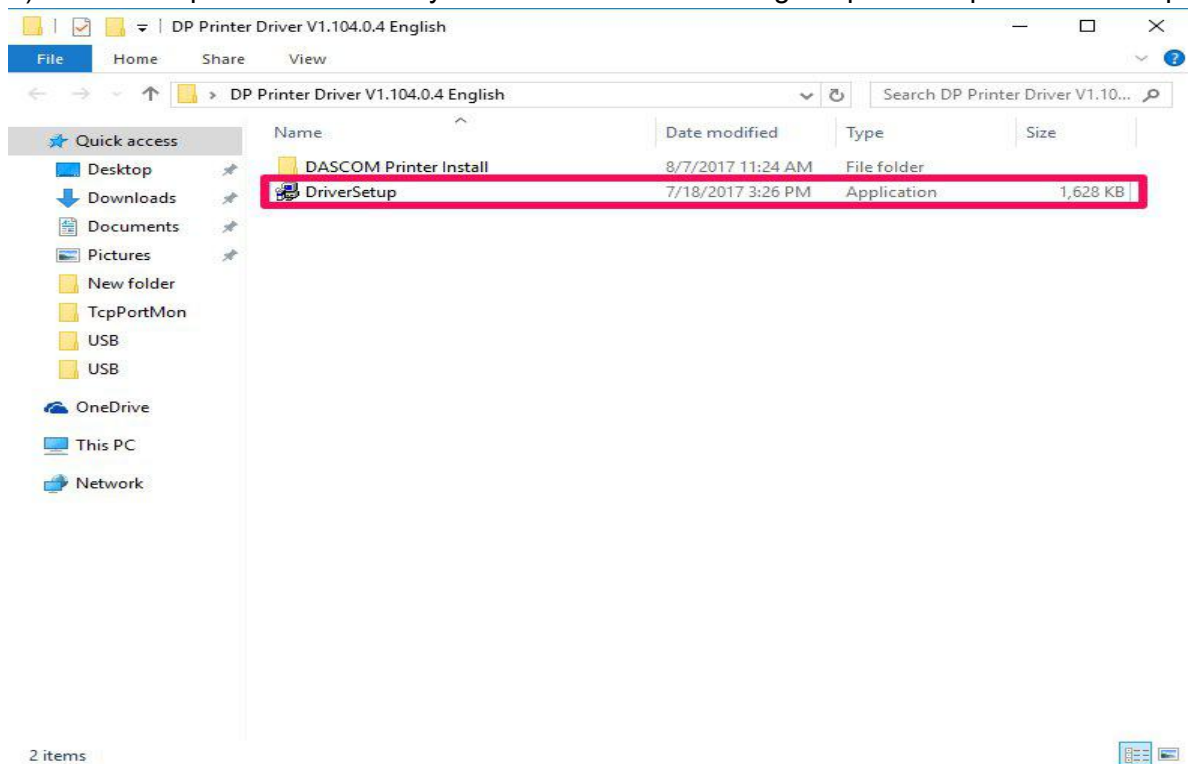

b) Select installing language.

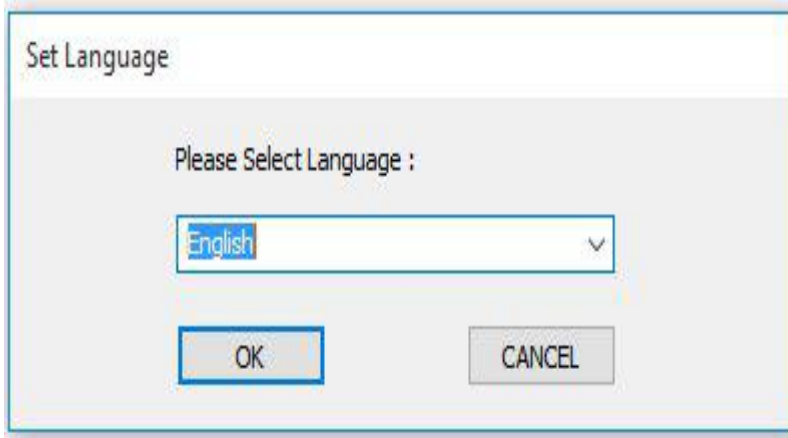

c) In the popup window, select Next to proceed. It pops out the tab 'Please select installation method'. Click OK for automatic installation; click Cancel for manual installation.

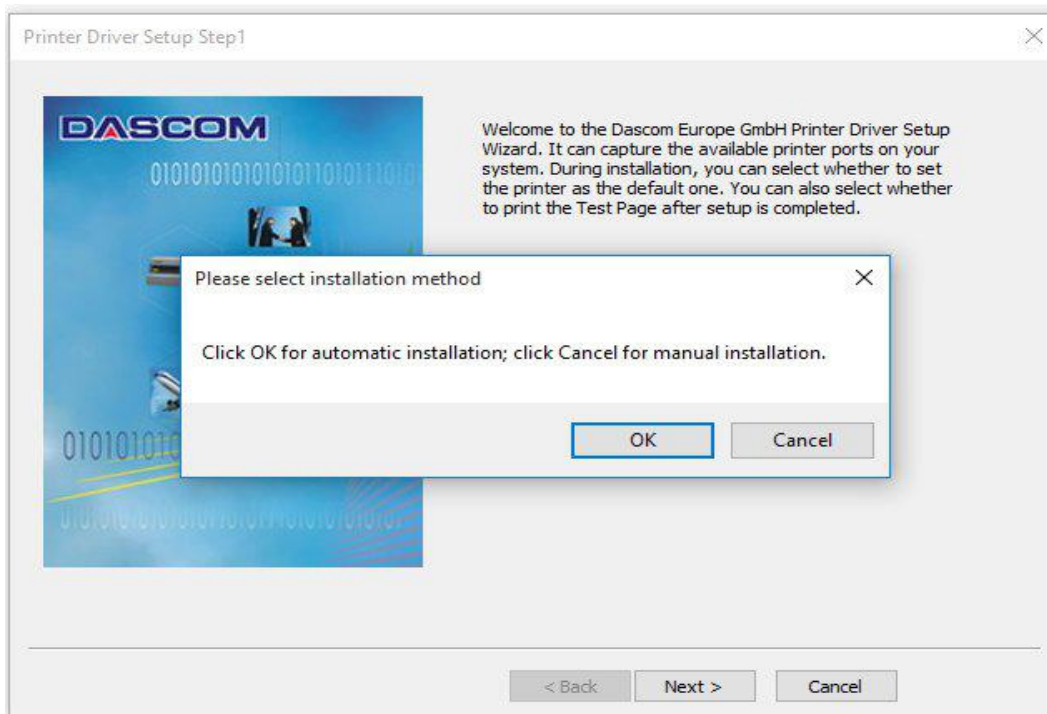

d) For automatic installation, the system chooses DASCOM DP-581; for manual installation please choose DP-581. Then click Next.

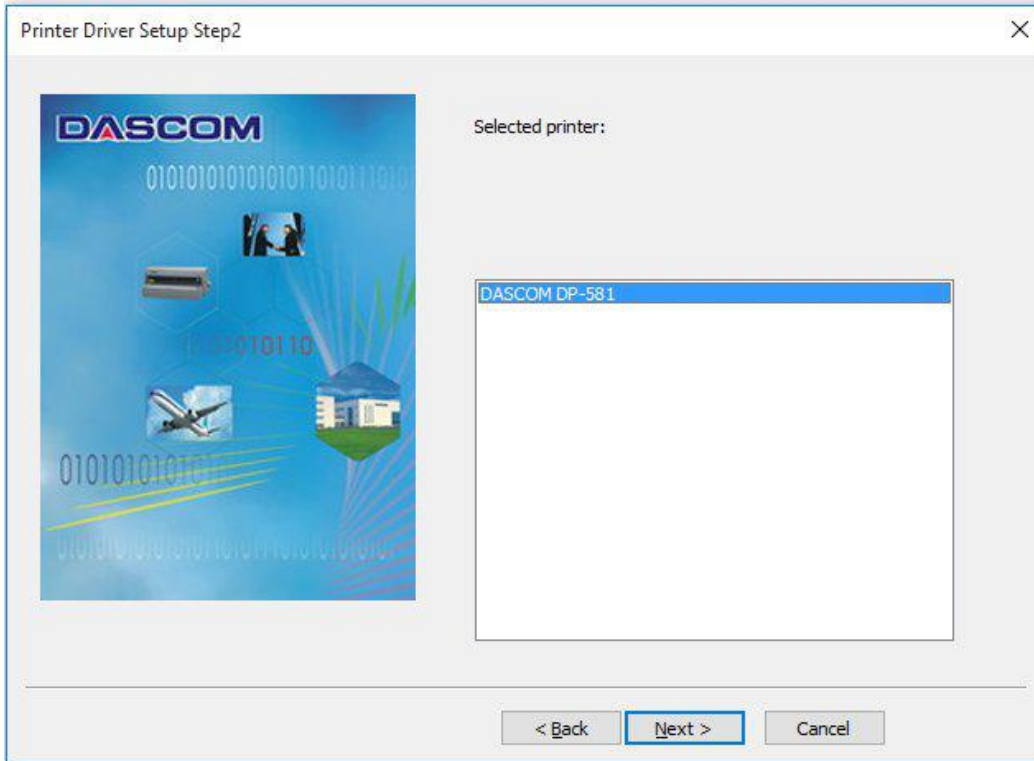

- e) For automatic installation, the system chooses USB001 port; for manual installation please choose USB001. Then click Next.

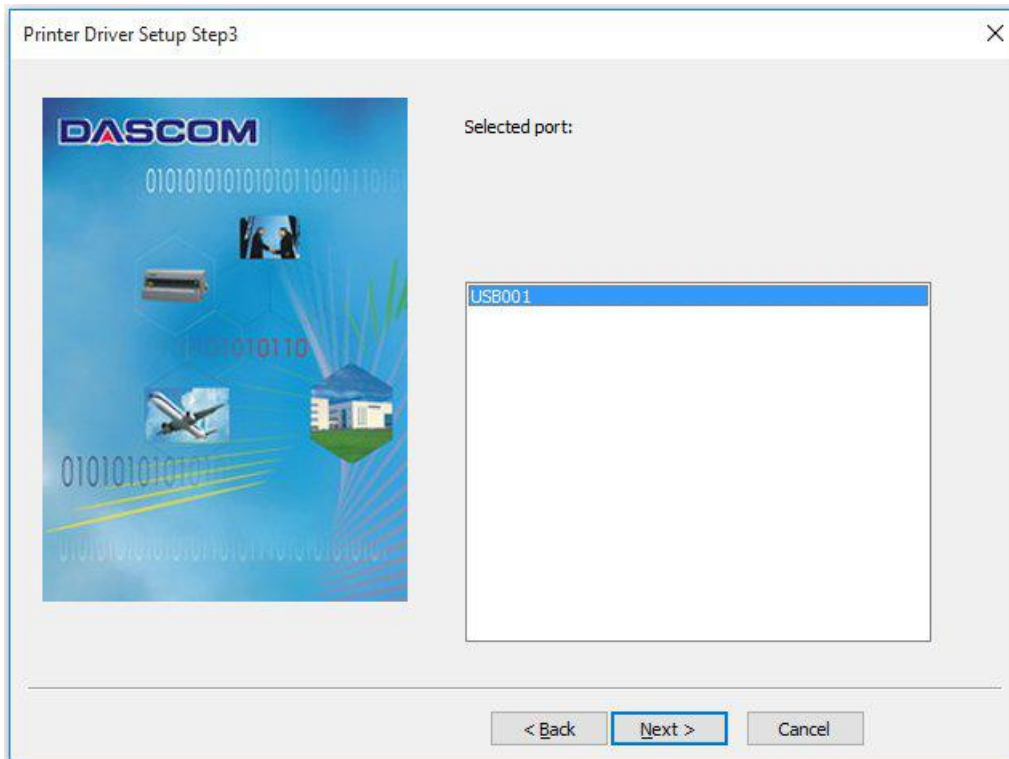

f) Click Next to proceed.



g) Click Finish to proceed.

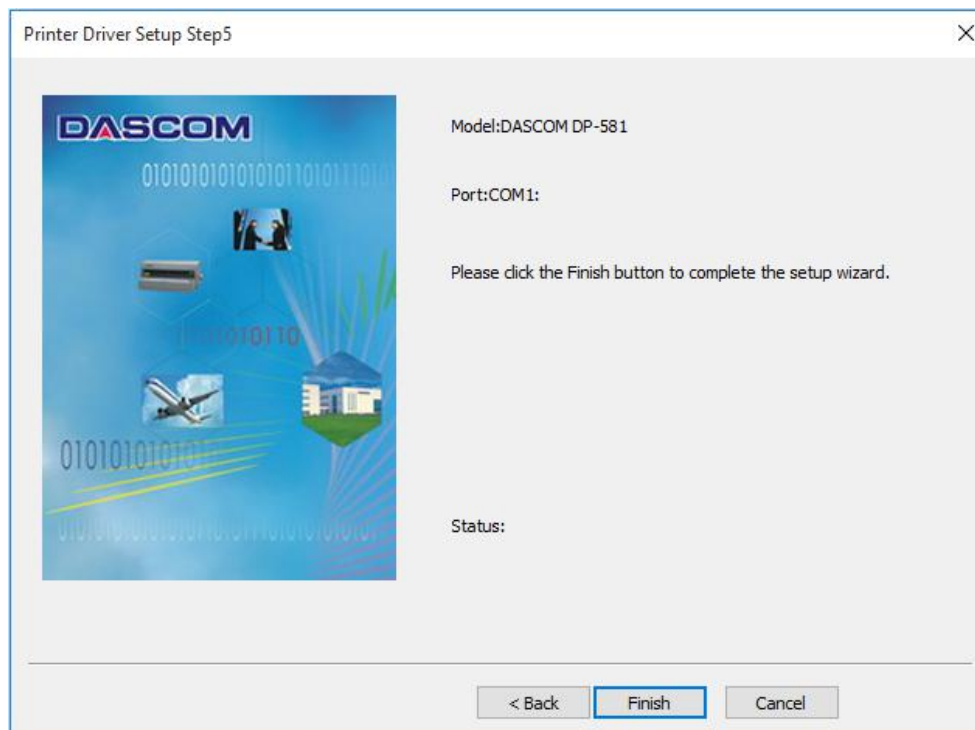

h) Click Install to proceed.

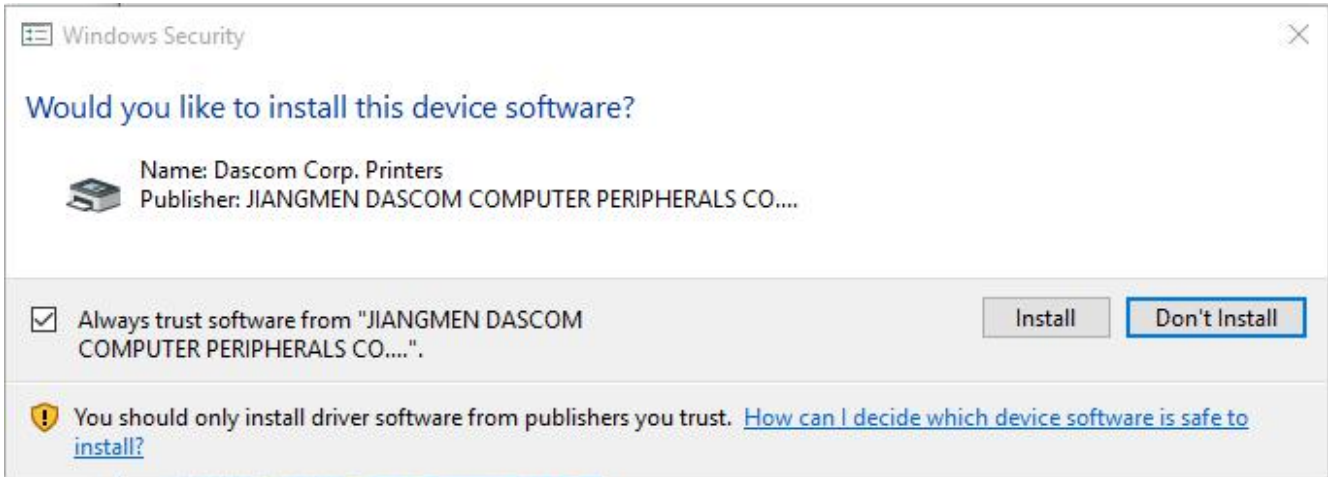

i) Install successfully.

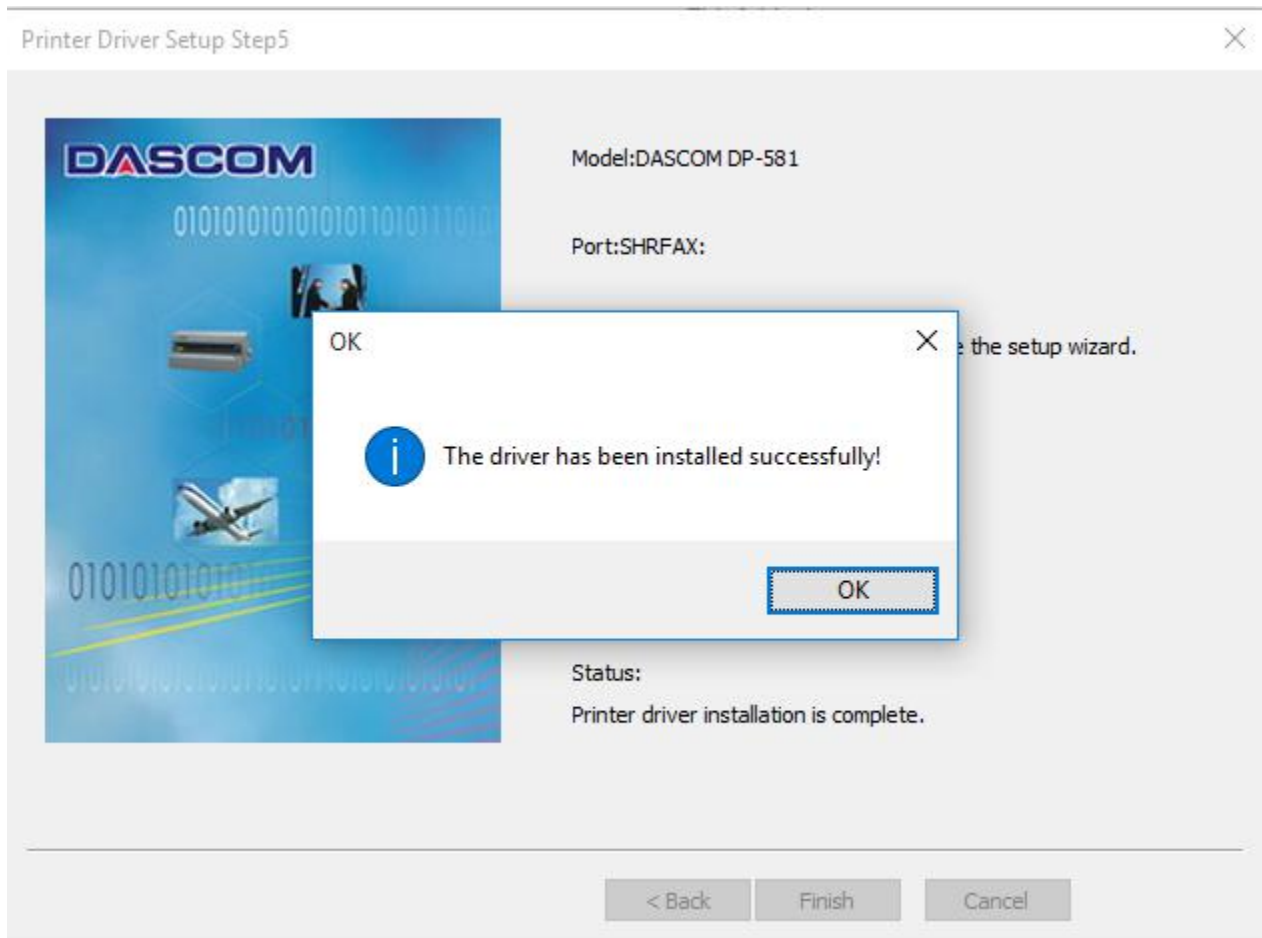

II. Bluetooth – General

- a) Turn on printer. Make sure Bluetooth on your host device is turned ON.
- b) Your host Bluetooth manager may automatically scan for new devices, or you may need to tell it to scan. The discover name of the DP-581 printer will be “DP-581-XXXxxxxx”, where XXXxxxxx = the Printer Serial Number.
- c) For Pairing, the default passkey is “0000”.

Note: Bluetooth host devices pair after discovery, but only **connect** to Bluetooth printers when the host application has asked it to print.

III. Bluetooth – Windows 7 and above

- a) Turn on printer. Make sure Bluetooth on your host device is turned ON.
- b) Open the “Devices and Printers” folder.
- c) Select “Add a Device”. The printer will display using the discover name listed above.
- d) Select the printer from the list of devices.
- e) Select “Enter the Device’s Pairing Code”. The default pairing code is “0000”.
- f) A window will display informing you the device was successfully added, and the printer name will appear in the devices list. Close this.
- g) Printer now appears under “Printer and Faxes” heading of the “Devices and Printers” screen, as “DP-581-*serial #*”. The icon may show that it is still configuring.
- h) Right click on the printer name or icon and select Properties. Select “Services” tab and deselect all items except for “SPP”.
- i) Now select “Hardware” tab. A virtual com port number will be listed here – make note of this COM Port number. Use this Com Port number when setting up the printer driver, under the “port settings”.
- j) Install the printer driver. Using the “Add Printer” wizard, install the printer using the driver file obtained from Dascom and the COM port number noted above.
- k) After the printer driver installs, the printer will appear as “DP-581-*serial #*” under the “Printers and Faxes” heading of your Windows “Devices and Printers” screen.

Ethernet Drivers

I. Install Win XP Ethernet Driver

a) Right click My Computer, choose Manage.

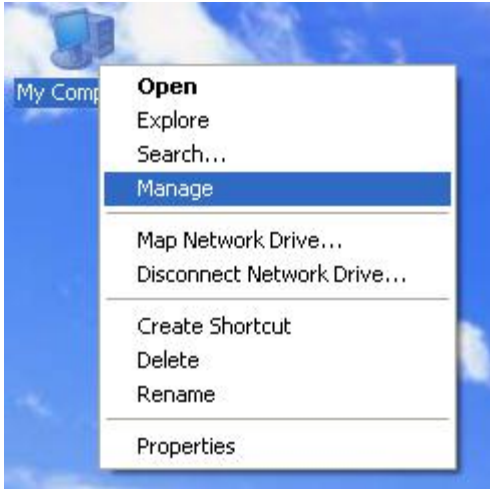

b) Choose Device Manager on the navigator tab on the left, right click "RNDIS/Ethernet Gadget" on the right. Click Update Driver.

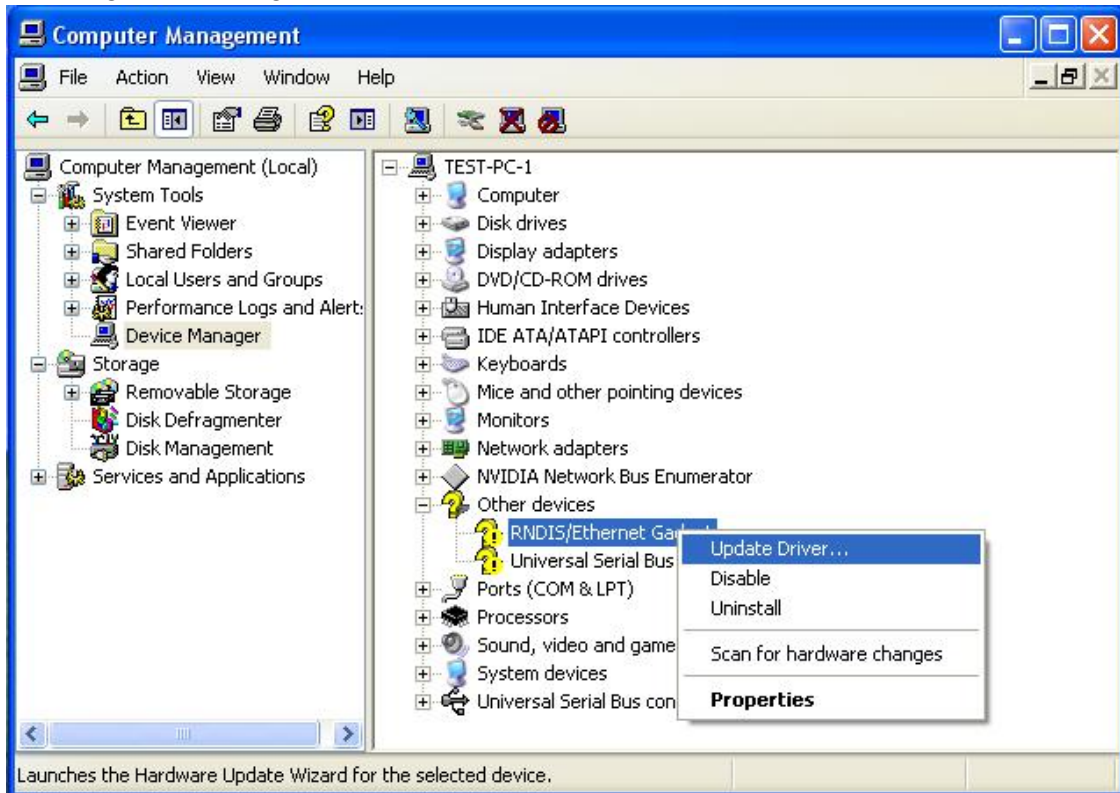

c) Select “No, not this time”. Then click Next.

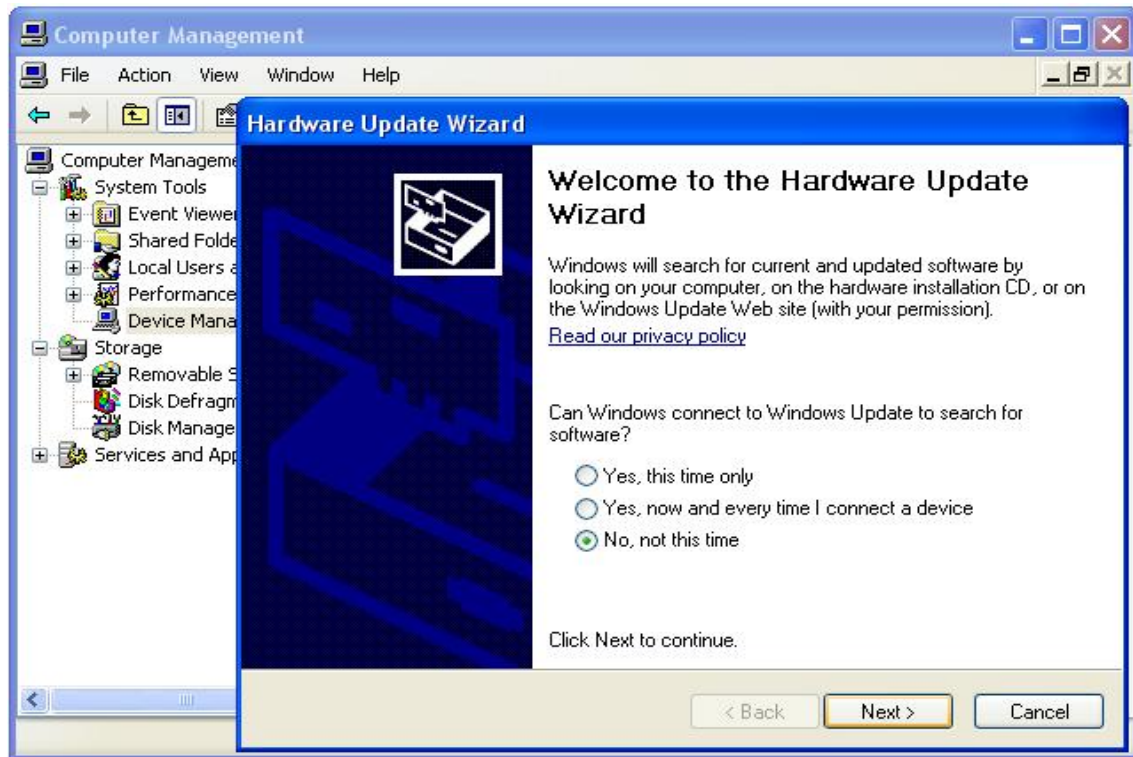

d) Select “Install from a list or specific location (Advanced)”. Then click Next.

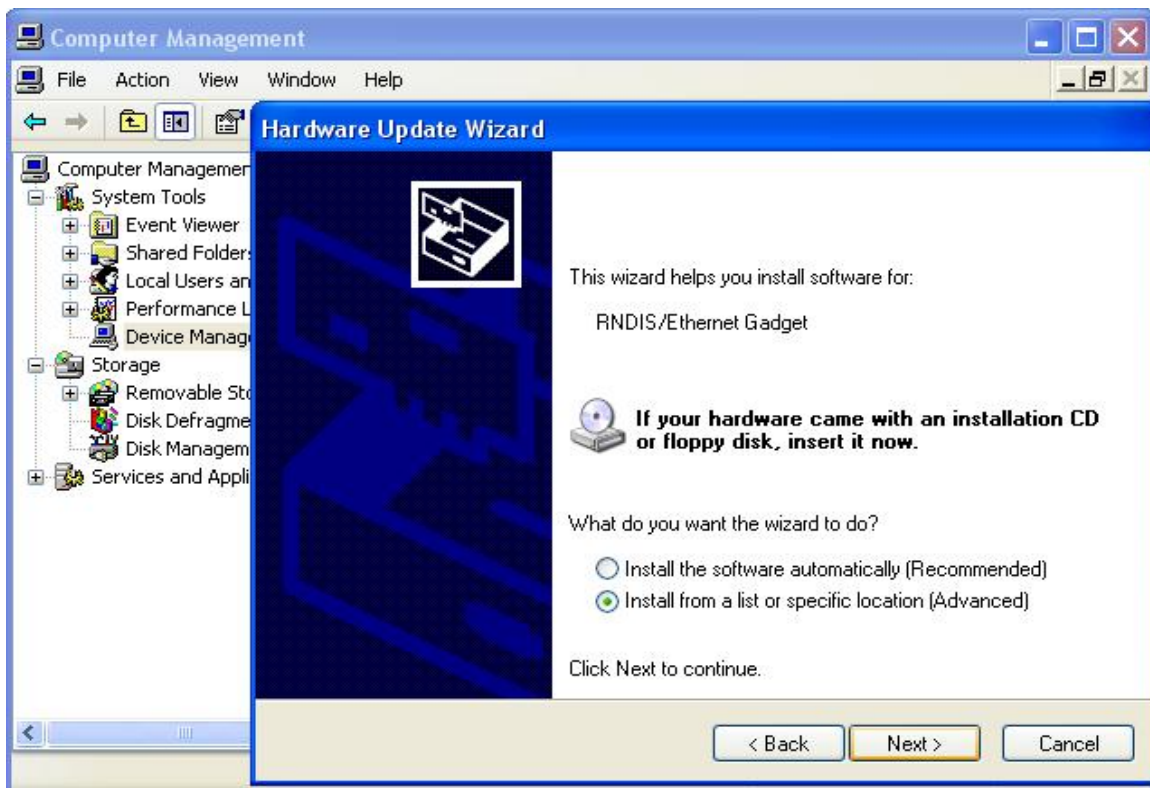

e) Select “Don’t search. I will choose the driver to install.” Then click Next.

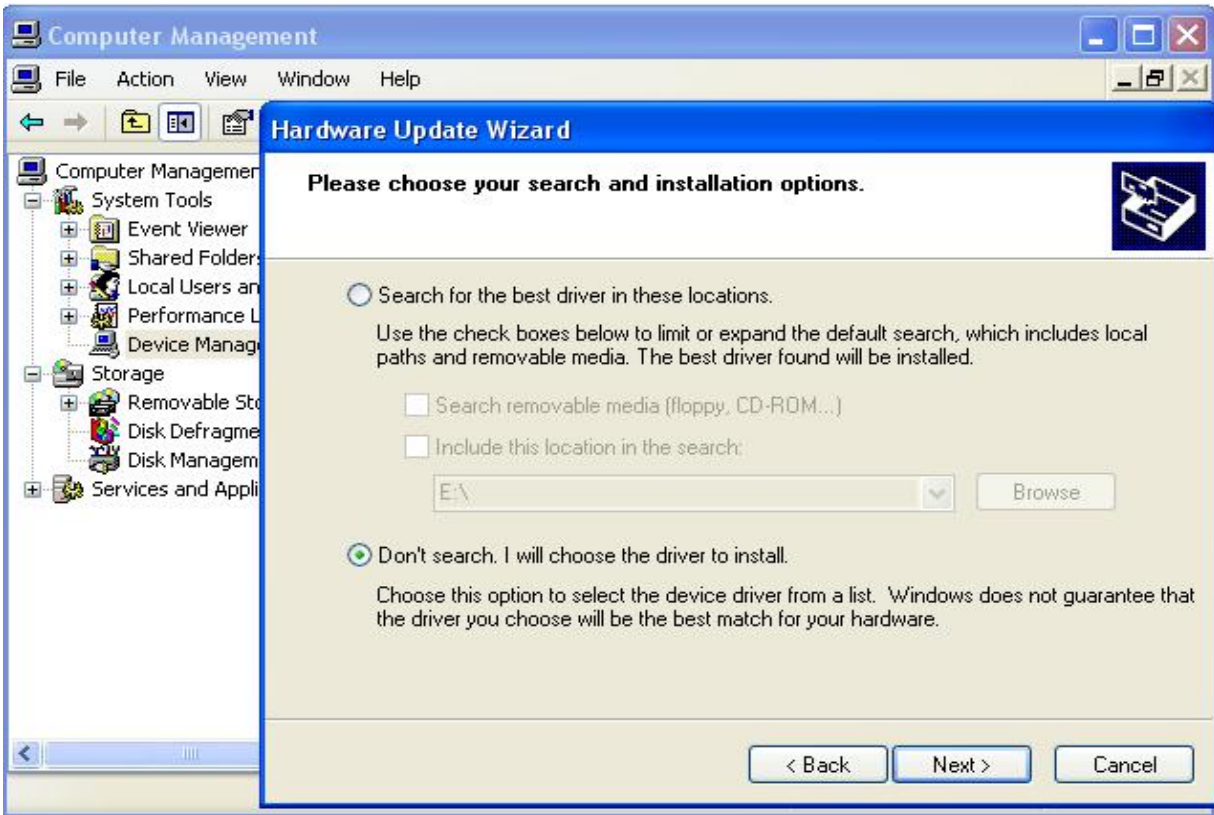

f) Select “Network adapters”. Then click Next.

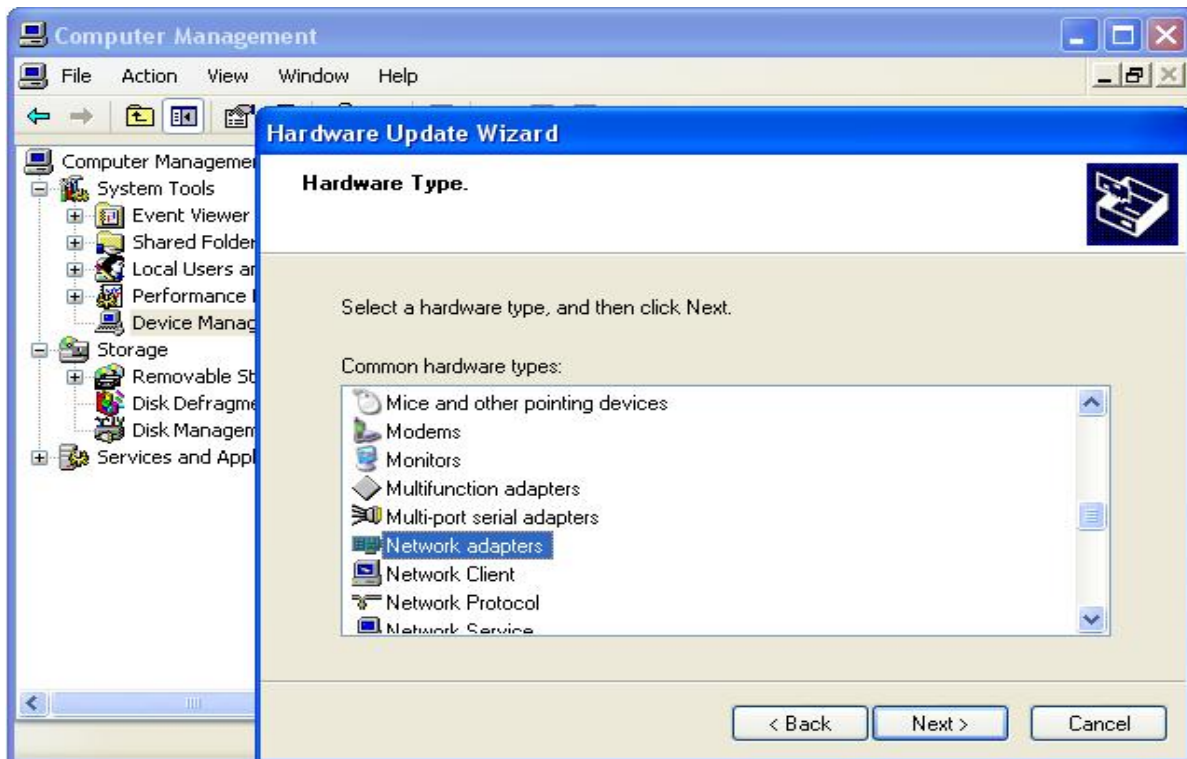

- g) Select “Install From Disk”, and select “Browse...” Choose RNDIS/Ethernet Gadget driver and click OK.

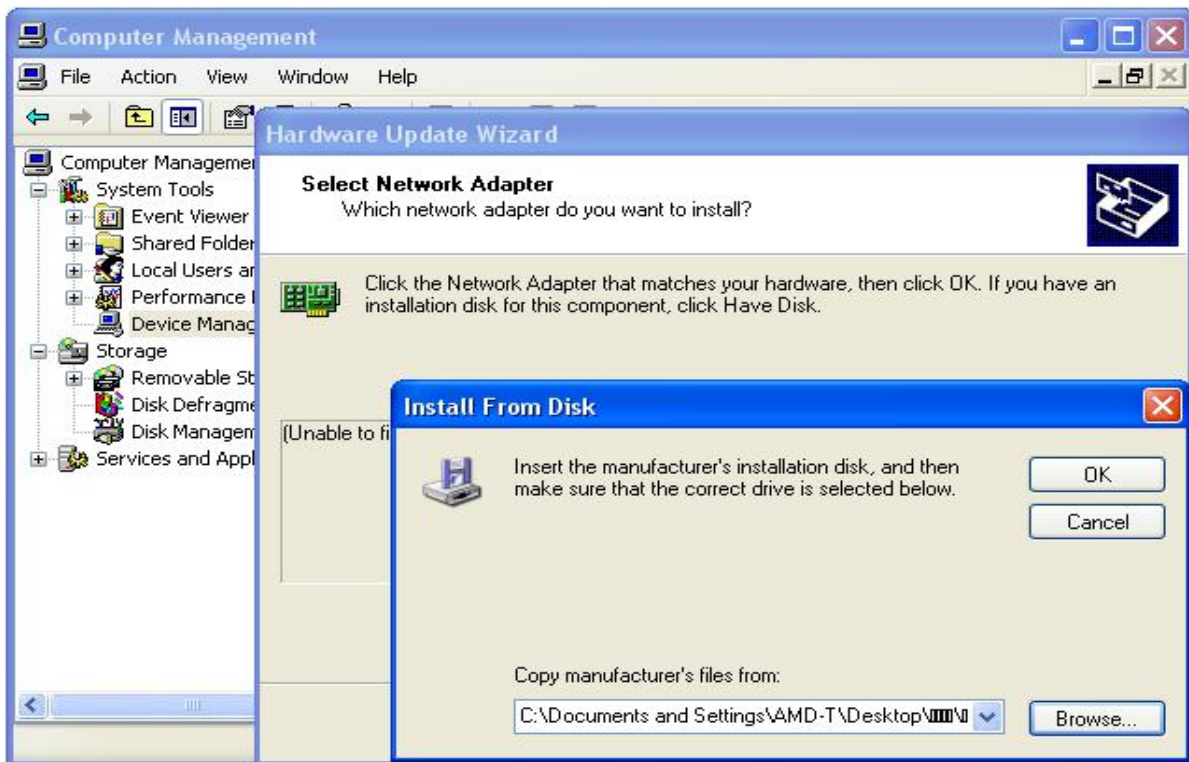

- h) Select “Acme USB Remote NDIS Network Device”, and click Next.

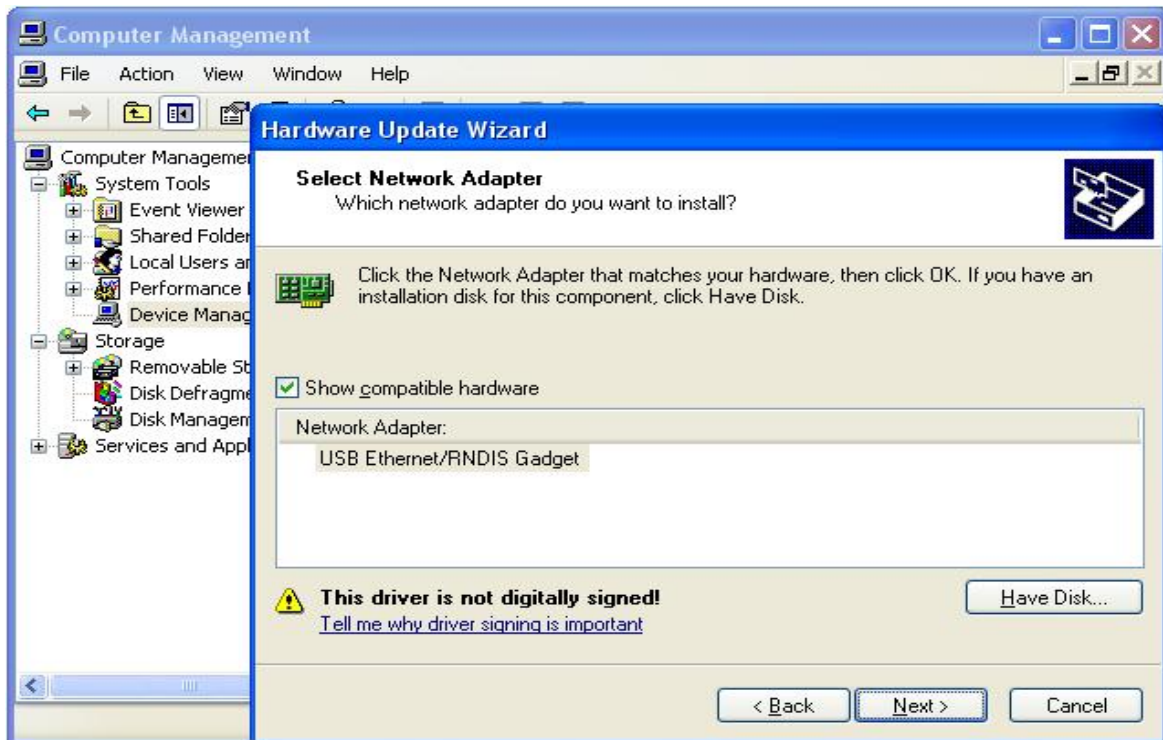

i) Select "Continue Anyway" to proceed.

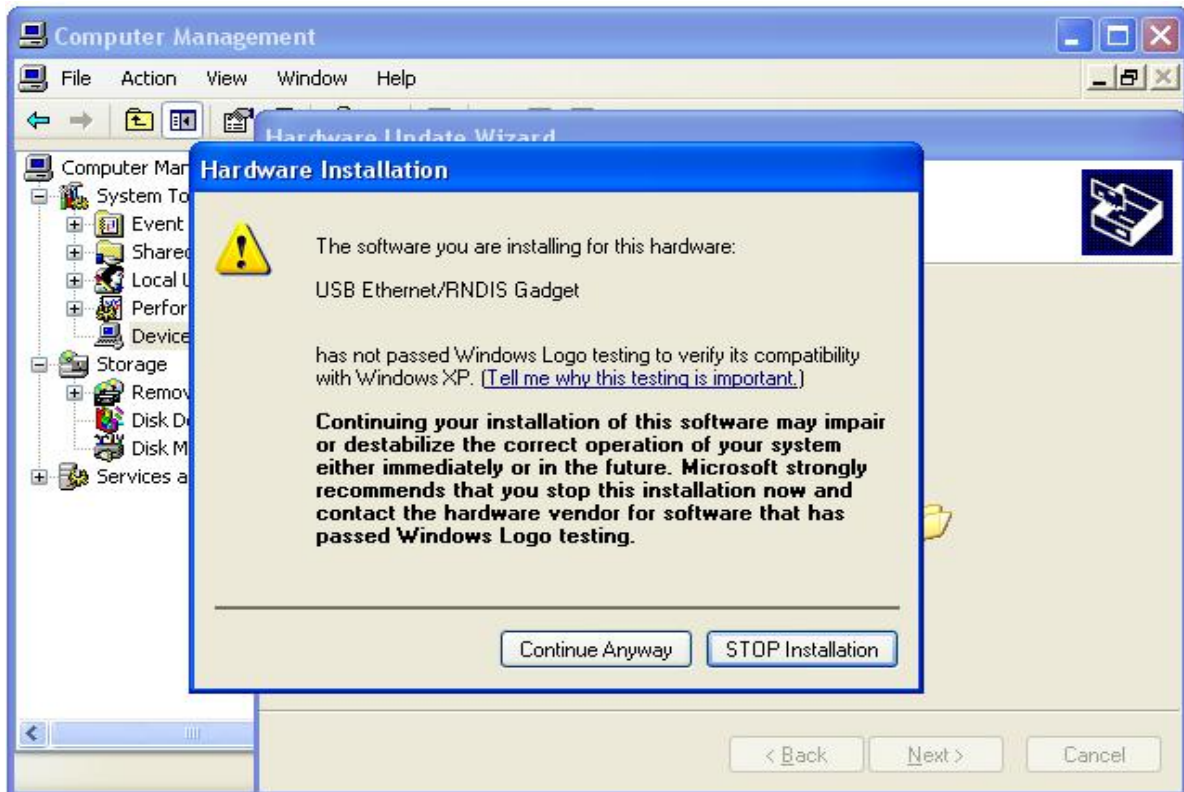

j) Installation complete.



II. Manually install Win 7/8 Ethernet Driver

- a) Choose Device Manager on the navigator tab on the left, right click “RNDIS/Ethernet Gadget” on the right. Click Update Driver Software...

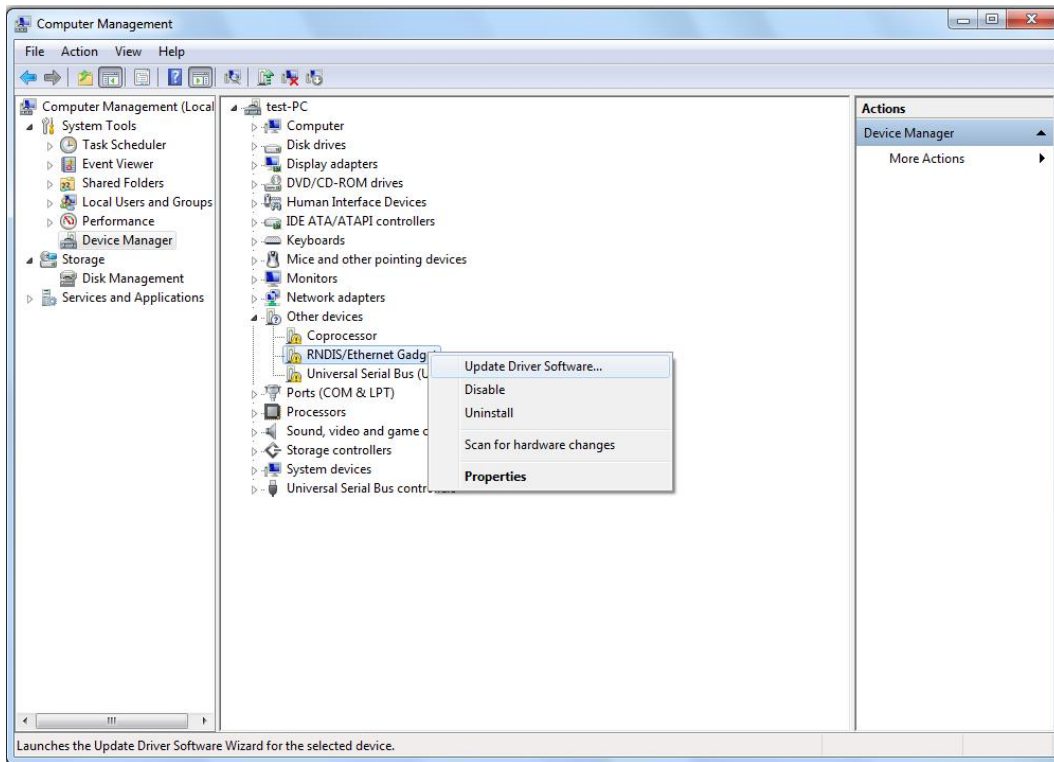

- b) Select “Browse my computer for driver software”.

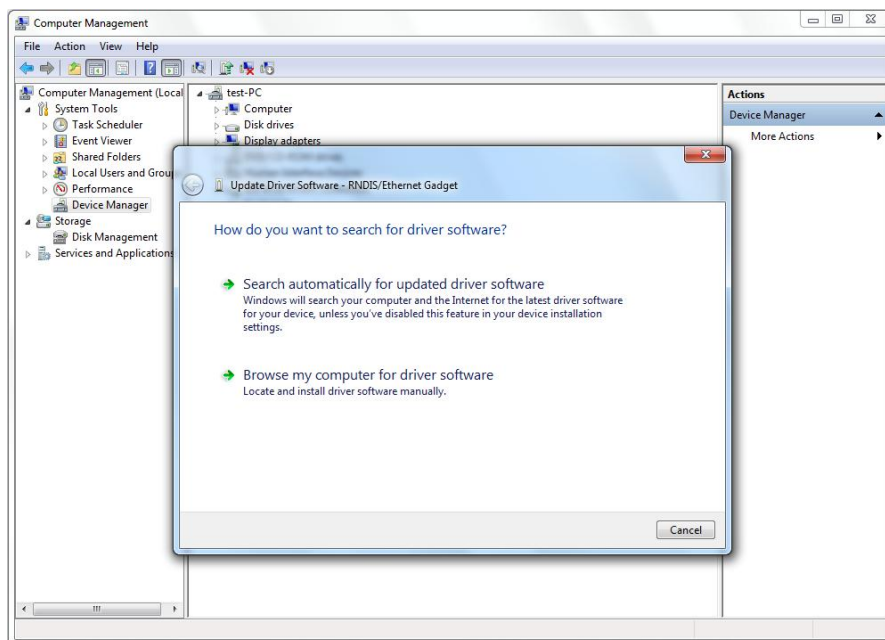

c) Select "Let me pick from a list of device drivers on my computer" .

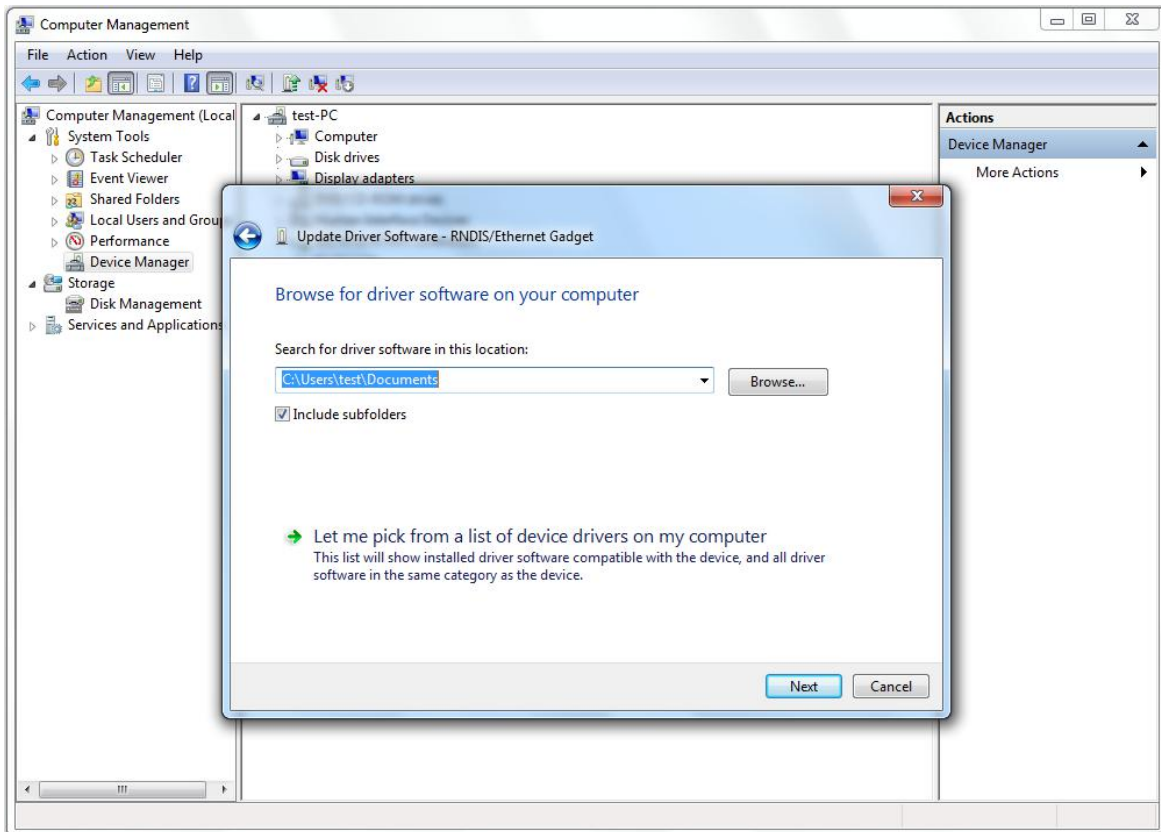

d) Select "Network adapters", and click Next.

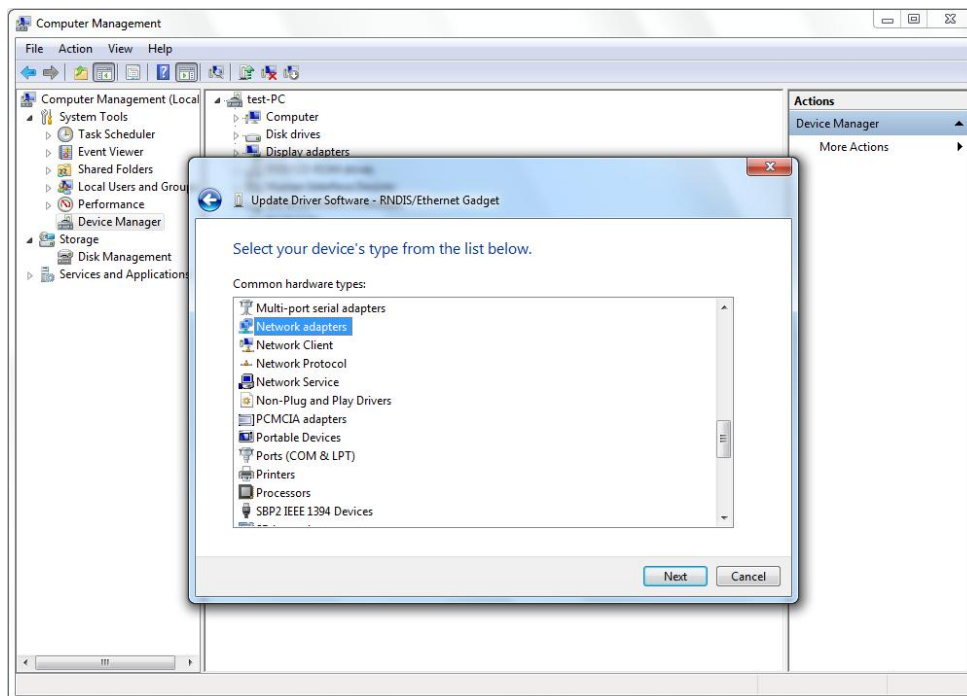

- e) Select “Microsoft Corporation” on the left, for Win 7 select “Remote NDIS Compatible Device”, for Win 8 select “Remote NDIS based Internet Sharing Device”, and click Next.

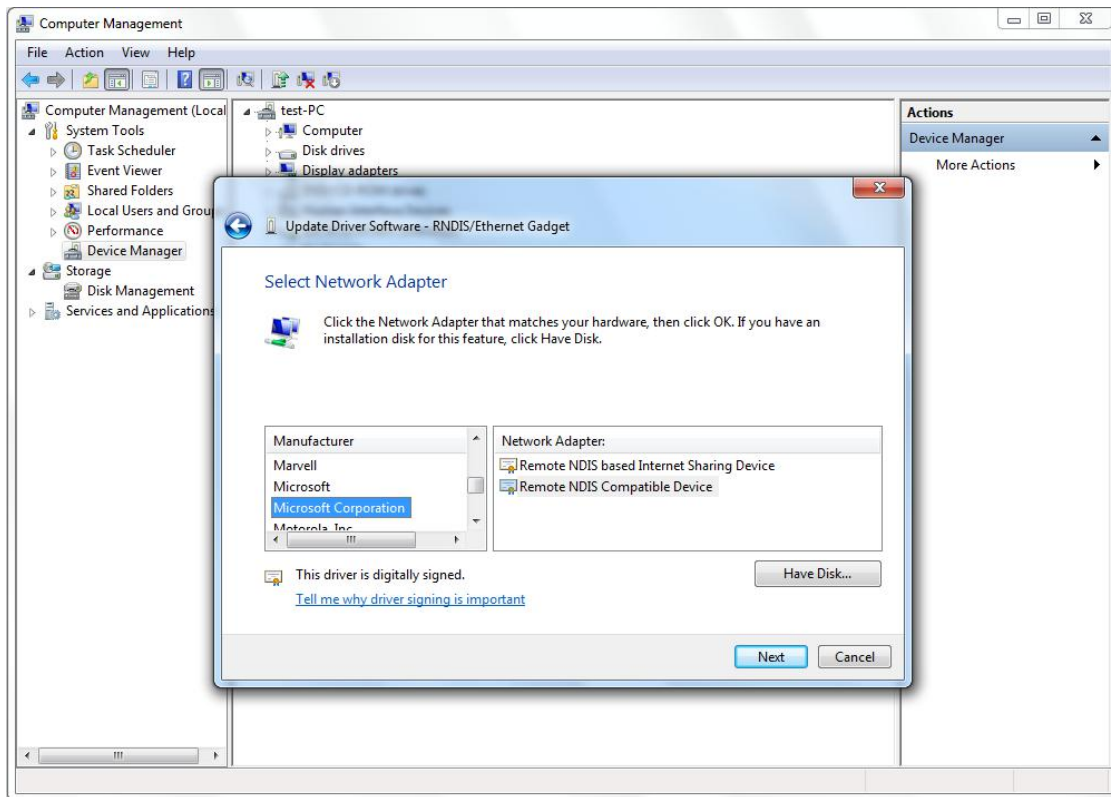

- f) Select “Yes” to proceed.

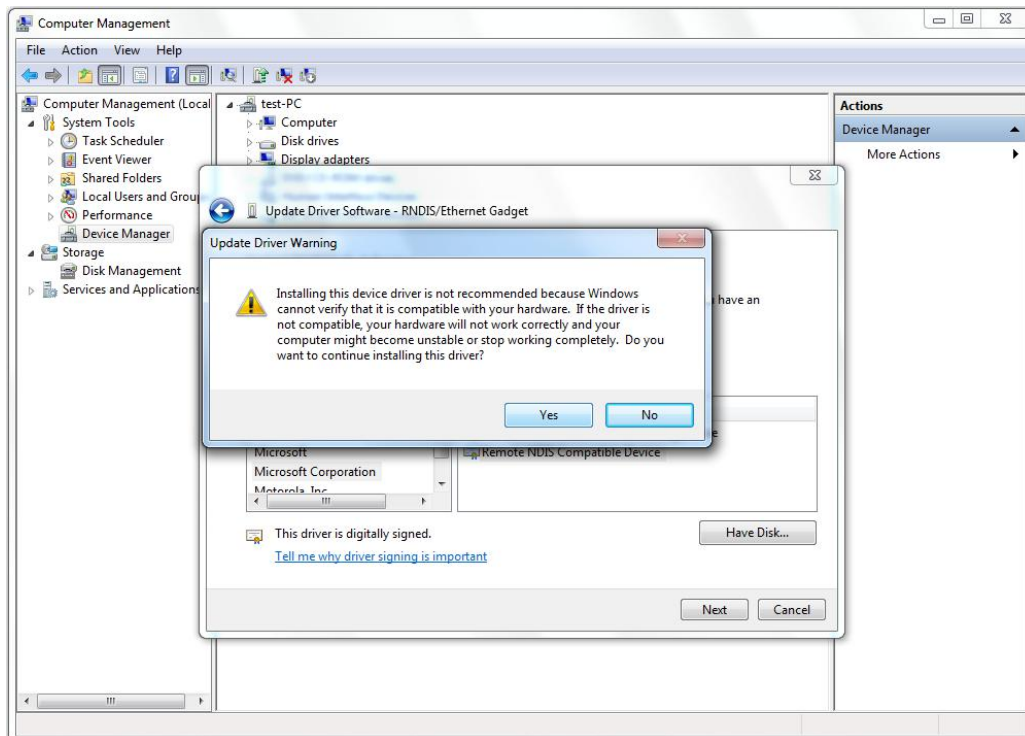

g) Installation complete.

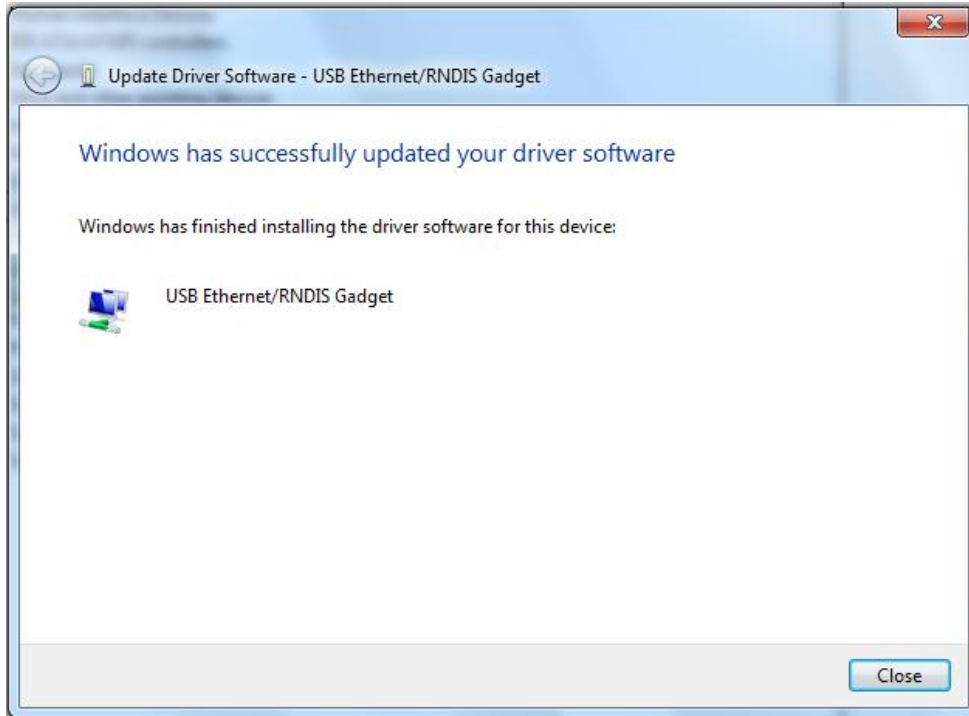

h) Select Network Location based on your actual needs.

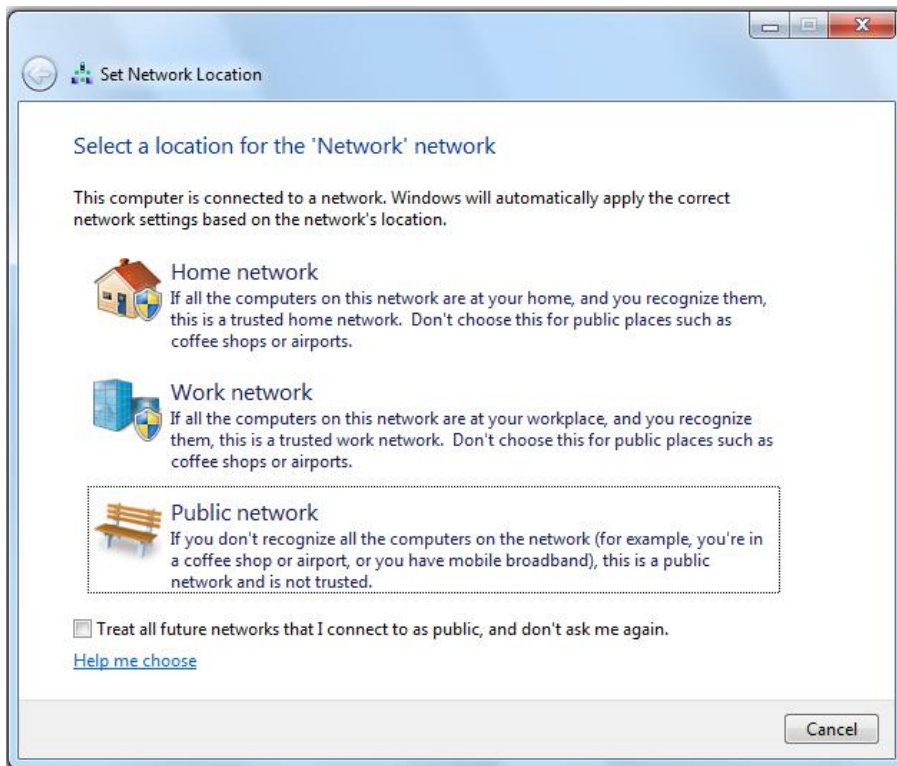

III. Install Win 10 Ethernet Driver

- a) Choose Device Manager on the navigator tab on the left, right click “USB Serial Device” on the right. Click Update Driver Software...

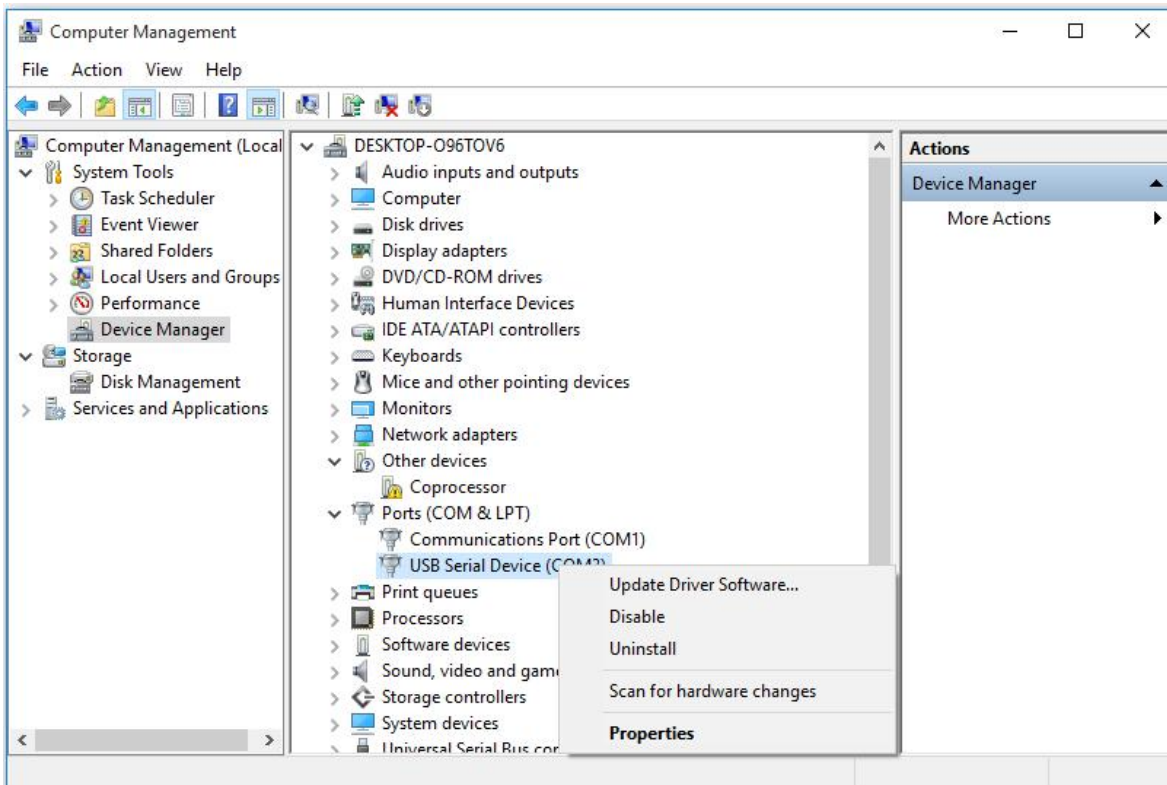

- b) Select “Browse my computer for driver software”.

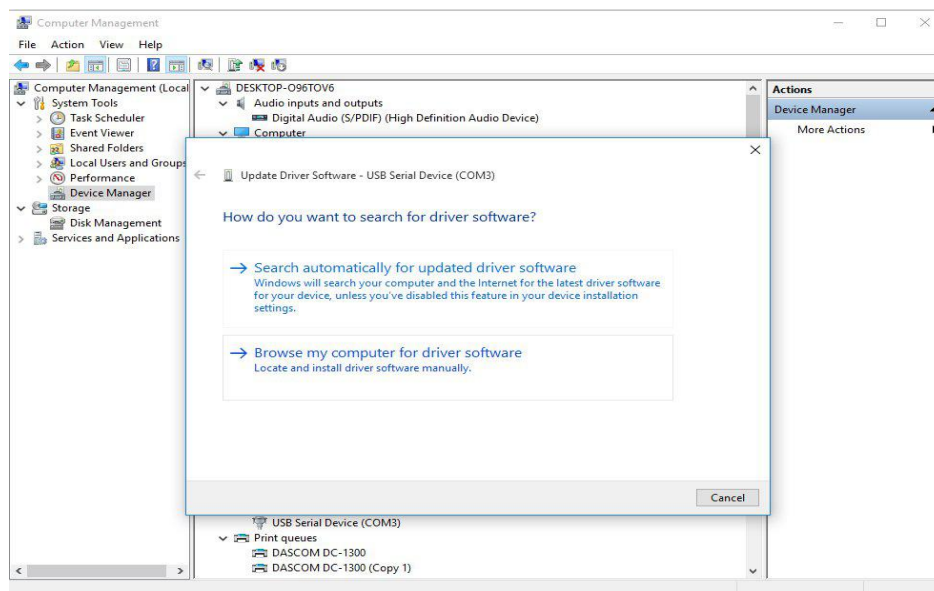

c) Select “Let me pick from a list of device drivers on my computer(L)”, and click Next.

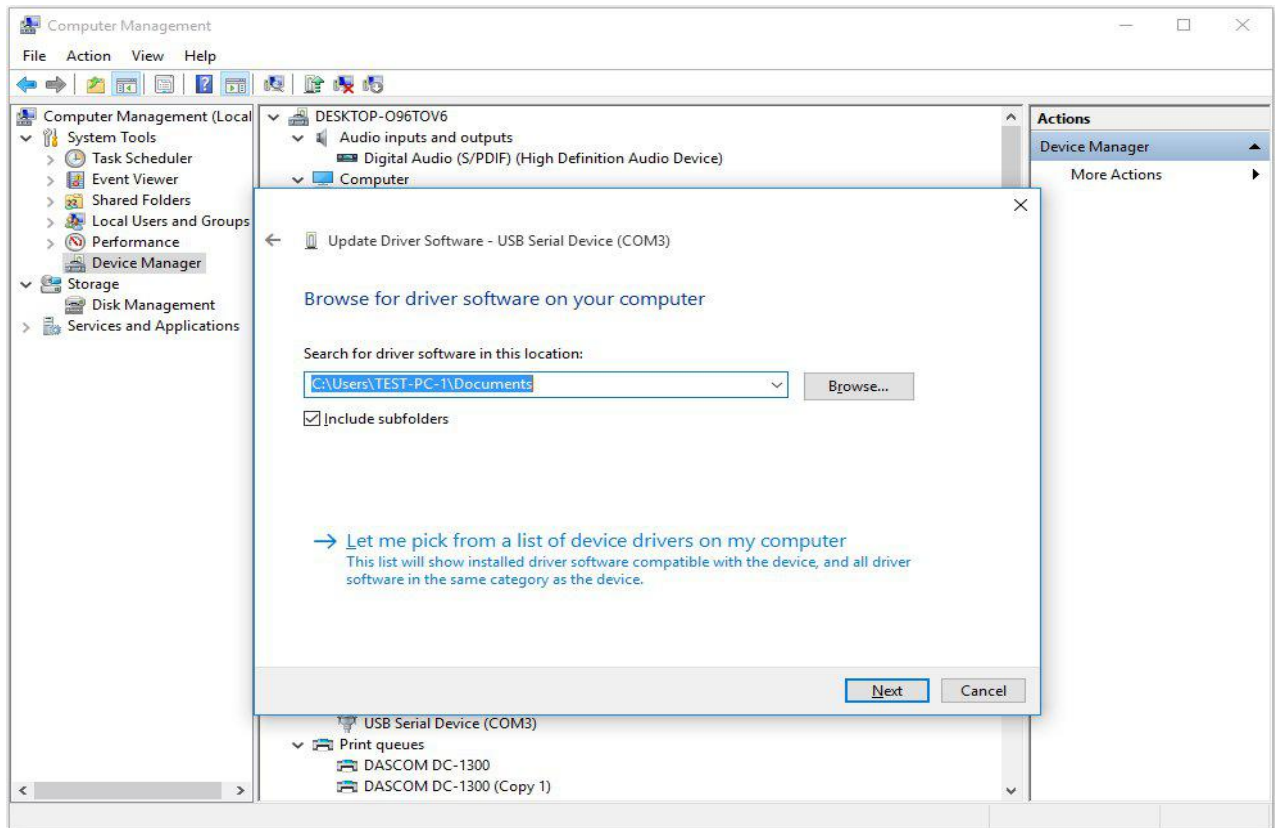

d) Select “Install From Disk”, and select “Browse...” Choose RNDIS/Ethernet Gadget driver and click OK.

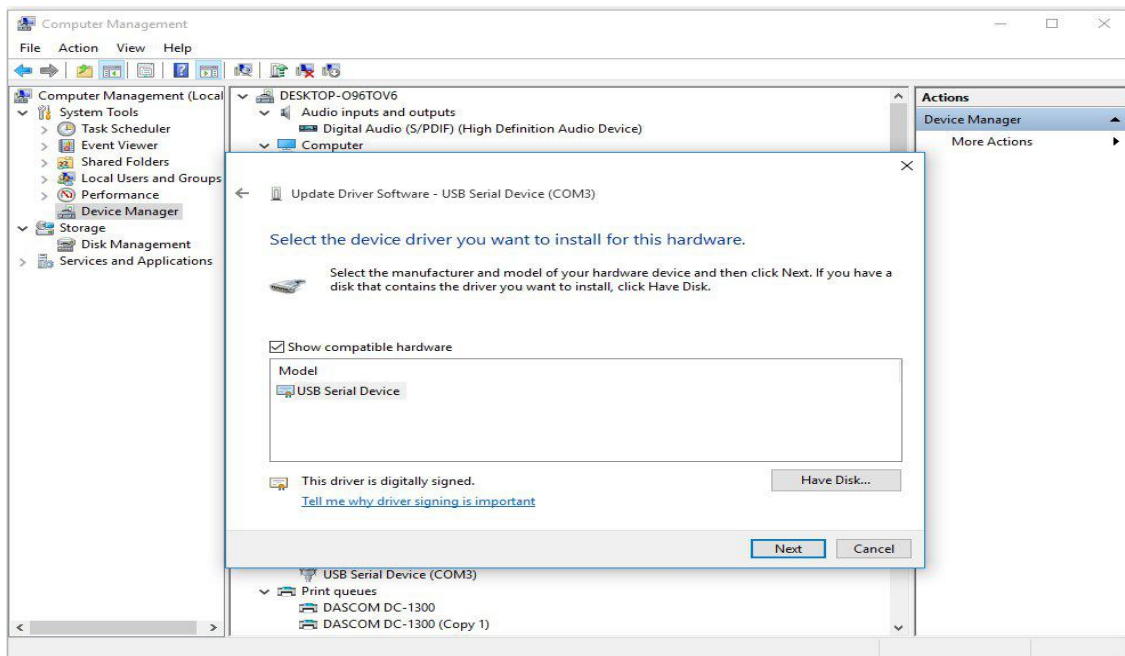

e) Select “Acme USB Remote NDIS Network Device”, and click Next.

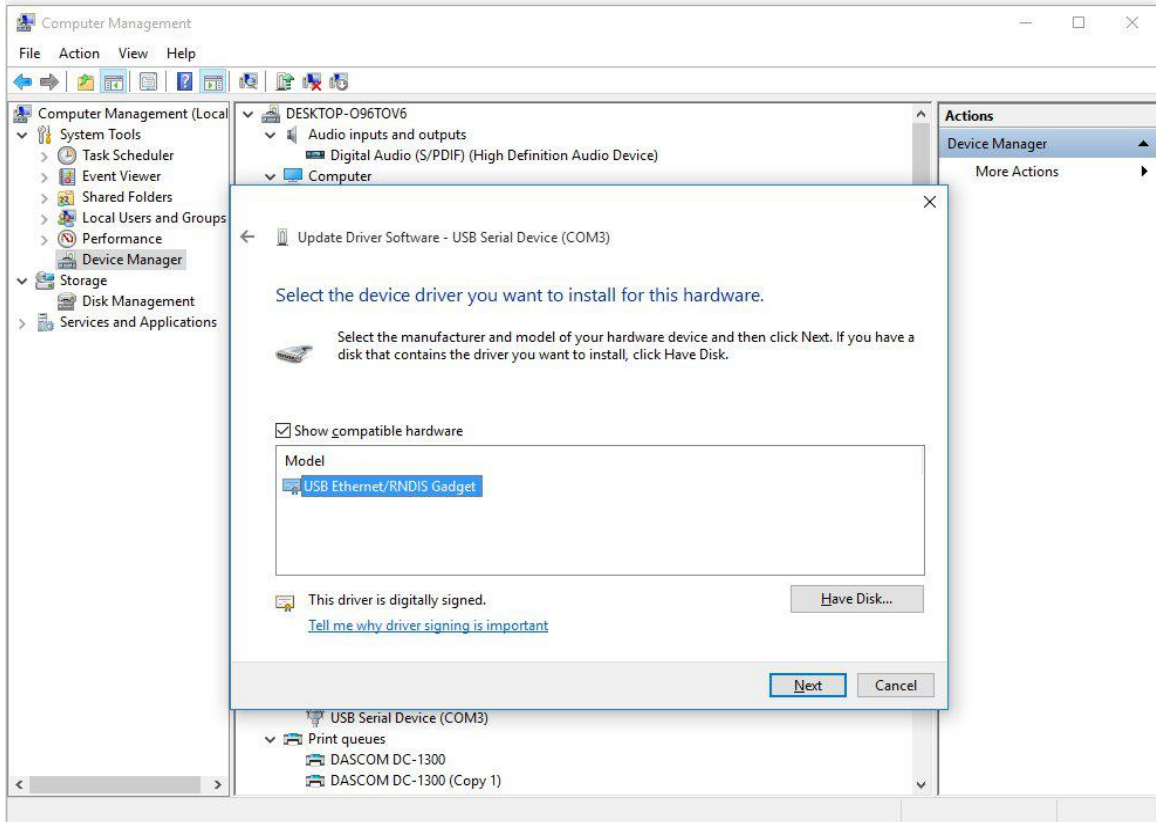

f) Installation complete.

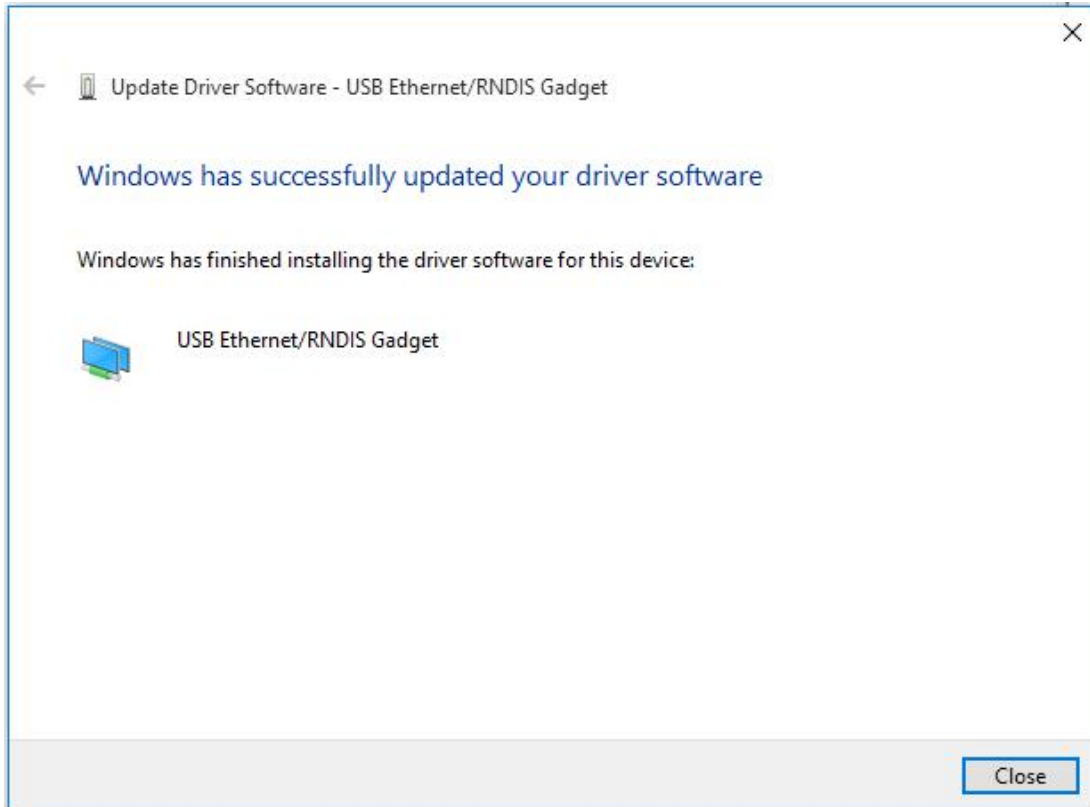

IV. Wi-Fi

Note: The following instructions are fundamentally the same for an Infrastructure or Wi-Fi Direct (peer to peer) setup. They also assume that you have already configured your Wi-Fi interface via the DP-581 printer web page (see the section on Configuration).

- a) Perform a configuration printout to verify the printer Wi-Fi setup and to record the IP address assigned and the Port number.
- b) Install the printer as a local printer using the USB instructions above.
- c) In the “Devices and Printers” screen, right click the printer icon representing your mobile printer.
- d) Under Printer Properties, select the Ports tab, then select “Add a Port”
- e) In the new dialog box which appears, select “Standard TCP/IP ports”; this will open the Standard TCP/IP Printer Port wizard.
- f) Follow the on-screen prompts in this wizard. You’ll use the IP address recorded above to set up the port. In the same screen you can also name the port something familiar and relevant, and this will appear as the name of the printer to the user.
- g) After the port is detected, it will be displayed as a “generic network card” – accept this by clicking Next / Finish.
- h) After you are finished adding the port, Windows will report it as a “Standard TCP/IP port”; click OK to accept this.
- i) Close the Printer Port window.
- j) Now in the Printer Properties dialog box your IP address (or the familiar name you assigned above) will appear in the list of ports available. Select it to configure the port.
- k) Windows defaults standard TCP/IP ports to port number 9100. The DP-581 Wi-Fi port number is internally set to 8023. Change the port number to 8023 in the Windows screen and click OK.
- l) Click “Apply” in the Printer Properties box.
- m) Your DP-581 printer driver should now be properly coupled to the Wi-Fi parameters you have chosen.

B. Windows Tablets and Smartphones

This feature and/or specific directions for use were not available as of this printing.

C. Android Tablets & Smart phones

I. Bluetooth

- a) Turn on printer. Make sure Bluetooth on your host device is turned ON.

- b) Your host Bluetooth manager may automatically scan for new devices, or you may need to tell it to scan. The discover name of the DP-581 printer will be “DP-581-XXXxxxxx”, where XXXxxxxx = the Printer Serial Number.
- c) For Pairing, the default passkey is “0000”.
- d) The printer should appear in your paired devices list.

Note: Android devices pair after discovery, but only **connect** to Bluetooth printers when the host application has asked it to print.

II. Wi- Fi

This feature and/or specific directions for use were not available as of this printing.

D. Apple™ Tablets & Smartphones

IV. Bluetooth

This feature and/or specific directions for use were not available as of this printing.

V. Wi-Fi

This feature and/or specific directions for use were not available as of this printing.

Media

A. Standard Media

Dascom offers a variety of media types. You may contact your Dascom sales representative for a complete and up to date description of our consumables and accessory products.

B. Black Mark Media Position

For automatic ticket printing, the Black Mark should be positioned as shown in the figure below. When using Mark Sensing mode (see [Configuration](#), earlier in this document), FieldPro printers will automatically position the output for tear-off and printing following a Form Feed command or by pressing the Paper Feed button.

For non-automatic paper positioning, refer to the *Integrator's Guide* for sensing and positioning commands.

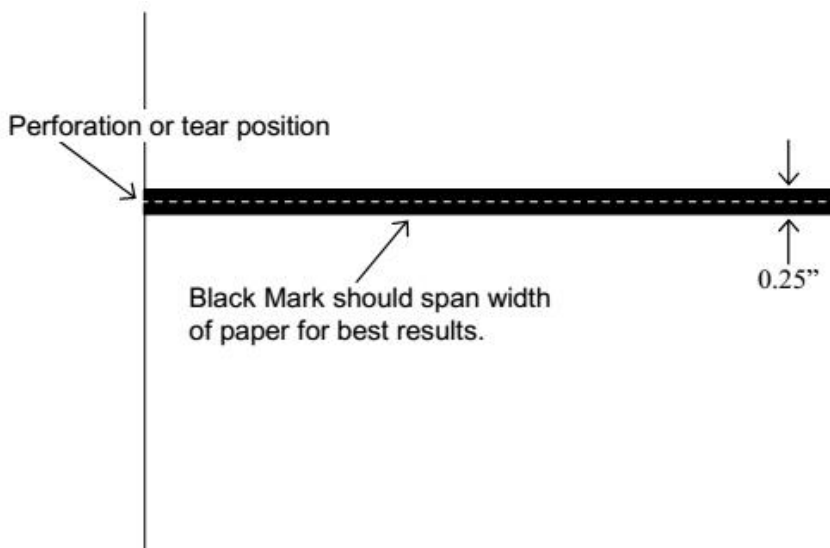

Optimum Black Mark Position

Maintenance and Troubleshooting

A. Cleaning

In normal environments, the printer should be cleaned after printing a few rolls of paper or if there are voids in the printout. For optimum performance and life, you should clean the Print Head and Platen Roller whenever you load new paper.

To clean the printer areas as described below, use a Thermal Head Cleaning Pen or you may use cotton swabs moistened with isopropyl alcohol.

- Turn the printer off. Open the Paper Door and remove the paper.
- Using a Thermal Head Cleaning Pen, clean the white ceramic surface on the Print Head.
Caution: Do not use sharp objects to clean the print head. This may damage the printer and require service. Such damage is not covered under warranty.
- Clean the Black Mark Sensor below the print head.
- Clean the Tear Bar.
- Clean the Platen Roller. Turn the Platen Roller with your finger to clean the entire surface.

You may also experience a buildup of paper dust in the printer. This may be removed using a can of compressed air or by vacuuming.

To clean the exterior of the printer, turn the printer off and use a soft cloth moistened with a mild detergent.

B. Battery Care

I. Storage

After a long period of storage of the printers and/or batteries without any initial use the batteries could be “deeply discharged” and cannot be recharged again. This is common behavior of Lithium-Ion batteries.

To avoid this behavior, we recommend for charging the battery annually to 20-40% capacity!

II. Getting the Maximum Battery Life

New batteries are shipped in an “uncharged” state and must be charged for at least 4 hours prior to the first use. Maximum battery capacity is not reached until after completing a minimum of three complete charge and discharge cycles.

III. Charging the Battery

- Plug the power adapter into a power source appropriate for the adapter being used.
- Plug the power adapter into the power connector on the side of the printer. The printer's battery charging circuitry will analyze the condition of the battery and begin charging it if necessary.
- If the battery is not fully charged, charging will begin and the Battery Indicator will illuminate.
- When the battery is fully charged, the Battery Indicator will turn off. Charging may take up to 8 hours (4 hours with external desktop charger accessory) depending on the condition of the battery.
- The printer may be used while the battery is charging, but this will extend the time required to fully charge the battery.
- The power adapter may remain connected to the printer to keep the battery fully charged and will not cause damage to the printer or battery.

IV. Additional Battery and Safety Information

- The FieldPro 581 series printers use an 11.25 volt 2950 mAH Lithium Ion battery.

Caution: Risk of explosion if battery is replaced by incorrect type. Dispose of used batteries according to the instructions.

- The recommended ambient temperature for charging is 68-77° Fahrenheit (20-25° Centigrade).
- Take the battery out of the printer when storing the printer for long periods of time. The battery storage temperature is 40-104° Fahrenheit (4-40° Centigrade). Do not store a fully charged battery at temperatures above this range for long periods of time or the battery may permanently lose charge capacity.
- Do not disassemble, short circuit, heat above 80°C, or incinerate the battery. The battery may explode.

- Only dispose of used batteries according to your local regulations.

V. Testing the Power Adapter and Battery

To verify that the printer's internal battery charger is functioning properly, perform the following steps.

- Test the power adapter (100-240VAC/50-60Hz, 12/24VDC adapter) with a voltmeter to verify that its output voltage is 19 VDC.
- Connect the power adapter to a power source and then connect it to the printer.
- Verify that the printer's Battery Indicator is illuminated. If illuminated, the charging circuit is functioning properly.

Note: If the battery is already fully charged, the Battery Indicator may not illuminate.

- After the battery has been charged for five minutes, disconnect the power adapter.
- Perform a printer Self-Test.
 - Make sure the printer is turned off.
 - Press and hold the Paper Feed Button while turning the printer on.
- If the printer successfully prints the Self-Test, the battery is functional. If the Self-Test does not complete and the printer turns off, repeat this test with a known good battery.
- Once this test has completed successfully, allow the battery to fully charge. At the end of this time the Battery Indicator will turn off.

If the printer and battery do not appear to successfully pass these tests, refer to the [Troubleshooting](#) section for possible causes and solutions.

Note: This test only verifies that the power adapter, the internal charging circuit, and the battery are functioning properly. This test does not provide a valid indication of the relative capacity of the battery or how long it may hold a charge.

C. Troubleshooting

When encountering problems, the cause may be the printer or may sometimes be due to other problems with your system. Please review the following tables to solve common problems you may encounter with your printer.

If you are still unable to solve your problem, please contact the company from whom you purchased your printer since they are most familiar with your systems. If they are unable to help you, please contact Dascom.

I. General Error Conditions

Whenever the printer detects an error condition the Alert (red) Indicator will either flash or stay on. In some cases the audible alarm will also sound. Please refer to the following table for a list of what causes these conditions and how they may be corrected.

Error Indicator	Possible Cause	Solution
Flashes	Paper Out or Paper Door not fully closed	Make sure the door is fully closed by opening the door and closing it again until the door "clicks" closed. Check the platen roller for damage.
Stays On, With Alarm	Print job too large for printer memory	Divide long documents into individual pages. Printer power must be cycled to clear error.

II. Fault Description and Resolution

Problem	Possible Cause	Solution
Printer will not turn on.	Battery not installed properly	Remove and reinstall battery making sure the battery is seated with door closed.
	Discharged battery	Recharge battery.
Printer turns itself off.	Battery discharged	Replace or recharge battery.

Problem	Possible Cause	Solution
	Electrostatic discharge	May occur in extreme low humidity conditions. Turn printer back on with power button.
Battery Indicator does not light or does not stay lit when power adapter is connected.	Battery already fully charged	No action required.
	Power supply not receiving power	Check building/vehicle circuit breakers/fuses.
	Faulty power adapter	Check output of power adapter with voltmeter. Should be 19 VDC.
Battery not charging.	Faulty power adapter or battery	Try new power adapter, or replace battery.
Poor print quality.	Low battery	Check and recharge battery.
	Print head dirty	Clean print head. Refer to " Maintenance " section of this document.
	Poor quality or "old" paper	Verify paper from approved source. Try new roll of paper.
Paper not feeding.	Obstruction in paper path, or paper improperly installed	Check paper path and reinstall paper (see " Quick Start Instructions ").
	Poor quality paper	Verify paper from approved source.
	Paper Door not fully closed	Verify door is closed.
Paper does not advance to black mark reliably.	Dirty Black Mark/Paper Sensor	Clean Sensor as described in " Maintenance " section of this document.
	Black Mark density/contrast	Adjust Mark Sensitivity as described in Device Settings Menu .
Paper not feeding reliably or print is compressed vertically	Poor quality paper	Verify paper from approved source.
	Heavy or thick forms; specialty paper with slick finish	Lower the Max Paper Speed as described in Device Config Menu .

Problem	Possible Cause	Solution
	Paper Door not fully closed	Verify door is closed.
Print Garbled.	Low Battery	Check and recharge battery.
	Improper Interface configuration	Verify printer and host settings match.
	Paper Door not fully closed	Verify door is closed.
Printer will not print.	Low Battery	Check and recharge battery.
	Paper not loaded correctly	Check paper path and reinstall paper (see " Quick Start Instructions ").
	Improper Interface configuration	Verify printer and host settings match. Print a self-test to verify printer settings and to verify printer is functioning properly.

D. Obtaining Service

If service is required for your printer, please contact the company where you purchased your printer.

If they are unable to assist you, contact Dascom retailer to obtain a Return Authorization Number. Printers without Return Authorization will not be accepted.

APPENDIX

A. Appendix A – DP-581 Printer Specifications

Printing Specifications

Printing Method: Direct thermal.
Printing Resolution: 203 dpi (8 dots per mm).
Printing Speed: Up to 2 ips (11 pages per minute).
Printing Width: Up to 8.27" (210mm)

Fonts/Characters/Bar Codes

Fonts: Virtually all TrueType fonts, from 6 cpi to 22 cpi depending on emulation chosen, plus scaling.
International Characters: All common sets available via UTF-8 encoding.
Bar Codes: Support common 1D and 2D codes, depending on emulation chosen.
Downloadable firmware, fonts, graphics, and logos.

Connectivity

Standard (All Units): USB 2.0 PNP.

USB-C connector.

Wireless Options:

Bluetooth®

Complete Bluetooth® 2.0 Stack
EDR

Wi-Fi 802.11b/g/n compatible

Software

Drivers and Utilities: Drivers for XP, WIN 7, WIN 8, WIN 10. Print utilities and SDK's for Android. Native App and Web printing.

Printer Setup via internal web page, access with browser from any host (tablets and smartphones included).

Emulations: Emulates many popular printer brands and languages including: Zebra CPCL and ZPL, and ESC POS. Firmware can be upgraded as new emulations become available.

Supports direct printing of Postscript, PDF, PBM, JPG, PNG, BMP, SVG and TIFF files.

Print Media

Paper Type: Direct Thermal Roll, Fanfold and Cut sheet.

Roll Size: Maximum roll diameter 2.125" (54 mm), roll widths from A4 to 8.5" (up to 216 mm).

Roll Capacity

Load Media: Approx. 100' (30 m)

Fanfold Size: Maximum width 216 mm, maximum length 305 mm, maximum total thickness 15 mm using fanfold tray.

Core Size: 0.75" (19mm)
Recommended.

Power Management

Battery: Rechargeable 6 cell Lithium Ion, (11.1 V, 6000 mAh, 66.6 Wh).

Endurance: Above 300 m printing per charge (@12.5% density).

Power Option: 100-240 VAC wall adapter. When plugged in, the printer can be used while recharging the battery or can be run without the battery (print & charge adapter).

Physical Specifications

D x W x H: 2.6" x 12.3" x 4.3" (66 x 312 x 109 mm)

Weight: 1.57 kg - without battery

1.92 kg - with battery

Environmental Specifications

Operating Temp: -10° to 45°C (using battery)

Storage Temp: -20° to 60°C

Humidity: 10% to 90% RH (non-condensing).

Operator Controls and Indicators

3 LED indicators for general fault, power and battery status indication. Buttons for power and paper feed. Sensors for paper out, black mark detection, and door open. "Gas gauge" on battery door.

Memory Capacity

256 MB Flash, 512 MB DDR2. Standard memory supports large and graphic intensive print jobs.

Durability and Reliability

Durable PC-ABS case.

Print head life: min 50km @ 12.5% coverage

MTBF: 20,000 hours in normal use.

Regulatory Approvals

FCC Class B, CE mark, RoHS, UL listed AC adapters.

Warranty

Depends on local requirements. Please contact your national DASCOS sales office.

Accessories & Options

- Direct thermal roll, approx. 3m/roll (if shipped with printer)
- AC Wall Adapter, 100 to 240 VAC (with power cord)
 - Print and charge version
- Battery
- Data cable: USB (USB-A to USB-C)
- Shoulder strap
- A4 paper width spacer
- Fanfold tray
- Media in Case Quantities (Direct thermal roll, approx. 26m/roll)
- Popular Mounting Systems
 - In-Vehicle Systems
 - Cart Mounting Systems
 - Fixed Mounting Systems

Glossary of Terms

802.11	Wireless networking communication standards created by IEEE.
Ad-Hoc	A Wi-Fi network consisting of only stations (no access point). Same as Peer-to-Peer.
authentication	The process a Wi-Fi station uses to identify itself to another station.
baud rate	The rate at which characters are transmitted over a serial interface. This is also often referred to as bits per second.
Bluetooth	A definition for short range radio frequency communications.
client	Any node on a network that requests services from another node (server).
character pitch	The horizontal spacing of characters. Measured in cpi.
cpi	Characters per inch.
default	Value or configuration assumed when the printer is powered on or reset.
DHCP	Dynamic Host Configuration Protocol. A method used to centrally control the assignment of IP addresses on a network.
dpi	Dots per inch. Generally used to refer to graphics density or resolution.
font	A group of characters of a given shape or style.
infrastructure	A Wi-Fi network consisting of stations connecting to a wired network or other stations via an access point.
interface	The connection between the printer and the host computer.
IP	Internet Protocol. A specification for packets, or datagrams, of data and an addressing method to allow the exchange of data with another system. Must be combined with another protocol such as TCP to create a complete connection with the other system.
LAN	Local Area Network.
LED	Light emitting diode.
lpi	Lines per inch.
margin	An area along any edge of a form where data may not be printed.

Peer-to-Peer	A network consisting of only stations (no access point or central server). Same as Ad-Hoc.
reset	Initialization of various operating features of the printer to the value or state assumed when the printer is powered on.
server	Any node on a network that provides services to another node (client).
SSID	Service Set Identifier. An identifier attached to packets on a Wi-Fi network that identify the particular network the packets are intended for.
TCP	Transmission Control Protocol. A specification that controls the connection between systems on a network.
top of form	The vertical position where the first line is printed on the paper. Also the position the paper is advanced to when a form feed (FF) character is received from the host or the Form Feed button is pressed on the printer's control panel.
USB	Universal Serial Bus.
WAN	Wide Area Network. Refers to connections that allow one LAN to communicate with another LAN(s).
WEP	Wired Equivalent Privacy. A security protocol for wireless LANs designed to provide data security similar to a wired LAN.
Wi-Fi	Refers to any of the IEEE 802.11 standards.
WLAN	Wireless Local Area Network. A LAN made up of wireless nodes.

Index

- 802.11, 30
- Add Enterprise Network, 11
- Add Personal Network, 11
- Address Method, 10
- Ad-Hoc, 30
- Alert, 6
- Android, 3, 20
- Android Tablets & Smart phones, 20
- Apple, 3, 21
- authentication, 30
- Auto Off Timer, 15
- AUTOIMAGE, 12
- Available Networks, 11
- Backup Distance Before Printing, 14
- battery, 3, 5, 7, 23, 24, 25, 26
- Battery Care, 23
- Battery Disposal, ii
- Battery Installation, 5
- baud rate, 30
- Bluetooth, ii, 2, 8, 9, 19, 20, 21, 30
- Canadian Department of Communications Radio Interference Statement, i
- character pitch, 30
- Charge Battery, 5
- Charging the Battery, 23
- Cleaning, 23, 29
- client, 30
- Com Port, 19
- Configuration, 7, 22, 30
- Connectivity Parameters, 8
- Contrast, 14
- Control Panel, 6
- CPCL, ii, 12
- cpi, 30
- Current Emulation, 12
- Current Logo Mapping, 16
- Current Printer Config, 10
- default, 30
- Default Font, 12
- Default Text Line Spacing, 13
- Device Config, 13
- DHCP, 30
- discover name, 19, 21
- Discoverability, 9
- dpi, 30
- driver, 19
- Drivers, 19
- ESCPOS, 12
- Fault Description and Resolution, 25
- FCC Part 15 Class B, i
- features, 31
- Font Aliases, 15
- Fonts, 15
- form, 31
- Front Paper Sensor Threshold, 14
- Gap Paper Sensor Threshold, 14
- GateWay, 10
- General Error Conditions, 25
- Graphics, 16
- IMAGE, 12
- Image Parameters, 12
- infrastructure, 30
- interface, 30
- IP Address, 10
- IP54, 3
- LAN, 30
- LED, 30
- Left Margin, 14
- lpi, 30
- Maintenance, 2, 23, 26
- margin, 30
- Mark Seeking, 14
- Max Mark Search Distance, 14
- Max Paper Speed, 13, 26
- Maximum Battery Life, 23
- Media, 2, 22, 27, 28, 29
- Mounting Options, 29
- Obtaining Service, 26
- Paired Mode, 8
- pairing code, 19
- Paper Energy Values, 14
- Paper Feed Button, 6
- Paper Load, 4

passkey, 19, 21
PDF, 12
Peer-to-Peer, 30
PIN, 8, 9
POSTSCRIPT, 12
power, i, ii
Power Button, 6
Power On, 5
Quick Start Instructions, 4
Rear Paper Sensor
 Threshold, 14
reset, 31
Role Policy, 9
Safety Information, 24
Self-Test, 6, 24
server, 31
Set Date, 11
Set index, 16
Set Width, 16
Specifications, 2, 3, 27, 28
SSID, 31
Stop Distance after Mark, 14
SubNetMask, 10
Supplies and Accessories, 2,
 29
TCP, 31
Testing the Power Adapter
 and Battery, 24
Troubleshooting, 2, 23, 24,
 25
Units, 13
Upload Digital Certificate, 12
Upload File, 16
Upload Font File, 15
USB, 19, 31
USB port, 2, 19
WAN, 31
web page, 7
WEP, 31
Wi-Fi, ii, 2, 20, 30, 31
WI-FI Config, 8, 9
Wifi Port, 10
Windows, ii, 3, 18, 19, 20
WLAN, 31
ZPL, 12